



# ALLIED MACHINE & ENGINEERING

Holemaking Solutions for Today's Manufacturing



Drilling



Reaming



Burnishing



Threading



Specials

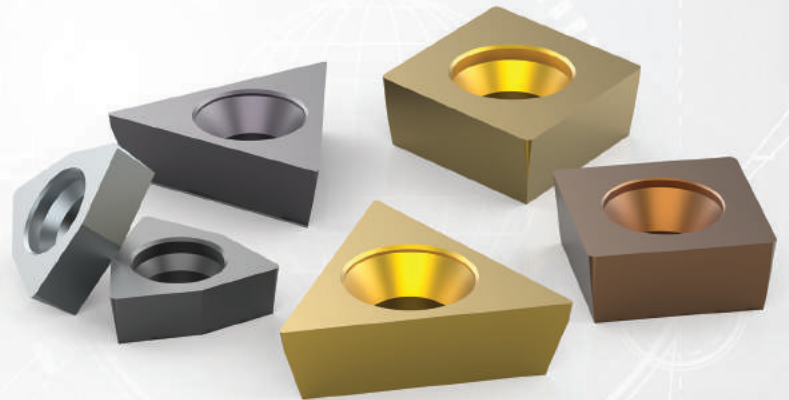

## Wohlhaupter®

► *BORING*

Inserts

**WOHLHAUPTER®**



SECTION

---

# B10-H

---

Inserts

# Wohlhaupter® Inserts

Replaceable Boring Inserts

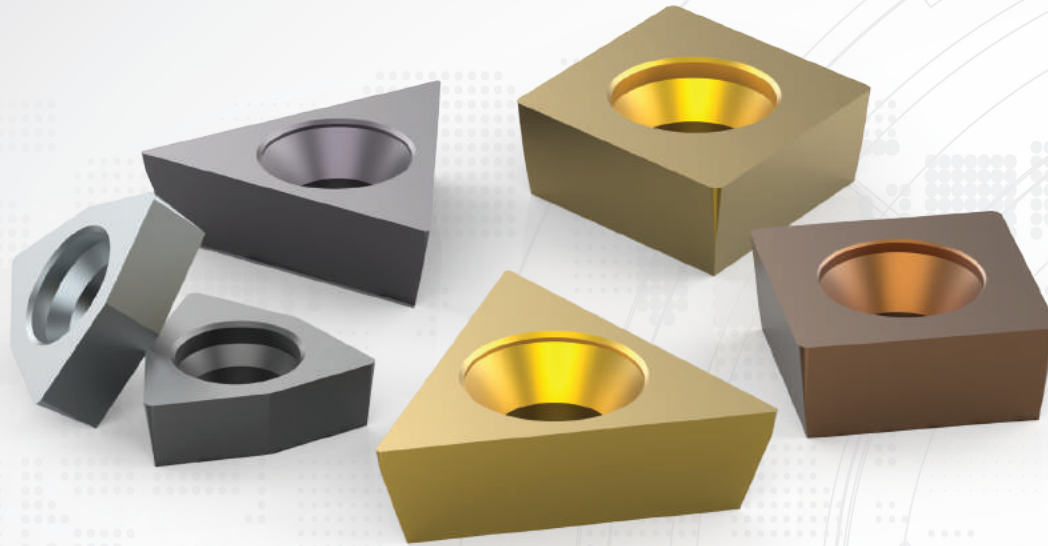

## Cutting-Edge Technology

Wohlhaupter has the cutting-edge technology to achieve all of your boring applications. With precision in mind, our inserts are available in multiple insert geometries, coatings, and nose radii. Wohlhaupter inserts are offered in uncoated and coated carbide, cermet, as well as CBN and PCD materials.

Try our easy-to-use boring insert selector available online or to download from the app store to find the perfect inserts for your boring applications.

[www.alliedmachine.com/bis](http://www.alliedmachine.com/bis)

## Applicable Industries



Aerospace



Agriculture



Automotive



Firearms



General  
Machining



Oil & Gas



Renewable  
Energy

Your safety and the safety of others is very important. This catalog contains important safety messages. Always read and follow all safety precautions.



This triangle is a safety hazard symbol. It alerts you to potential safety hazards that can cause tool failure and serious injury.

When you see this symbol in the catalog, look for a related safety message that may be near this triangle or referred to in the nearby text.

There are safety signal words also used in the catalog. Safety messages follow these words.

### **WARNING**

**WARNING** (shown above) means that failure to follow the precautions in this message could result in tool failure and serious injury.

**NOTICE** means that failure to follow the precautions in this message could result in damage to the tool or machine but not result in personal injury.

**NOTE** and **IMPORTANT** are also used. These are important that you read and follow but are not safety-related.

Visit [www.alliedmachine.com](http://www.alliedmachine.com) for the most up-to-date information and procedures.

**Reference Icons**

The following icons will appear throughout the catalog to help you navigate between products.

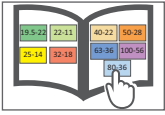

**MVS Connection Color Guide**

Detailed instructions and information regarding the MVS connection(s)

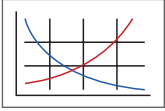

**Recommended Cutting Data**

Speed and feed recommendations for optimum and safe boring

**Wohlhaupter® Inserts Table of Contents**

**Product Nomenclature**

Wohlhaupter Product Nomenclature . . . . . 2  
 ISO Insert Nomenclature . . . . . 3

**Insert Grades . . . . . 4 - 9**

**Insert Geometries . . . . . 10 - 13**

**Insert Forms**

Form 211 . . . . . 14 - 15  
 Form 20 . . . . . 16 - 17  
 Form 161 and 163 . . . . . 18  
 Form 47 . . . . . 19  
 Form 101, 103, 104, and 105 . . . . . 20 - 25  
 Form 37 and 39 . . . . . 26 - 27  
 Form 112, 113, and 114 . . . . . 28  
 Form 04 and 05 . . . . . 29  
 Grooving Insert Form 89, 90, and 91 . . . . . 30 - 31  
 Grooving Insert Form 304 . . . . . 32 - 34  
 Grooving Insert Form 325 . . . . . 35

**Insert Accessories . . . . . 36 - 37**

**Technical Information**

Surface Finish and General Formulas . . . . . 38  
 Wiper Geometries . . . . . 39

**Recommended Cutting Data**

Imperial . . . . . 40 - 43  
 Metric . . . . . 44 - 47

**Wear Patterns . . . . . 48**

**WOHLHAUPTER®**

**Boring Insert Selector**

**Find the best insert for your application.**

- Generate the correct boring insert for your job in just six easy steps
- Choose type, shape, substrate, insert form, nose radius, and material
- Order easily by adding the item to your cart

[www.alliedmahcine.com/bis](http://www.alliedmahcine.com/bis)

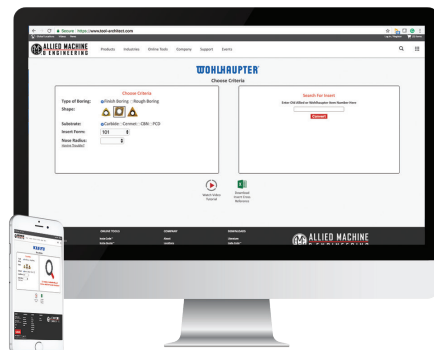

## Wohlhaupter Insert Product Nomenclature

### Reference Key

Symbol	Insert Type
▼	Roughing - Main Application
▽	Roughing - Extended Application
▼▼	Universal - Main Application
▽▽	Universal - Extended Application
▼▼▼	Finishing - Main Application
▽▽▽	Finishing - Extended Application

### Reference Key

Symbol	Machining Conditions
●	Good - Main Application
○	Good - Extended Application
●	Average - Main Application
○	Average - Extended Application
⚙	Difficult - Main Application
⚙	Difficult - Extended Application

### Reference Key

Symbol	Wohlhaupter Insert Grades
<b>WHW</b>	Uncoated carbide (HW)
<b>WHC</b>	Coated carbide (HC)
<b>WHT</b>	Uncoated cermet (HT)
<b>WTC</b>	Coated cermet (HC)
<b>WCN</b>	Ceramic cutting material (CN)
<b>WBN</b>	Cubic boron nitride CBN (BN)
<b>WBC</b>	Coated CBN (BC)
<b>PCD</b>	Polycrystalline diamond PCD (DP)

### Wohlhaupter Inserts

<b>F101</b>	<b>04</b>	<b>M</b>	<b>N</b>	-	<b>158</b>	<b>W</b>	<b>D</b>
1	2	3	4		5	6	7

1. Wohlhaupter Insert Form	
211	262
20	264
161	112
163	113
47	114
101	04
103	05
104	89
105	90
123	91
124	304
39	325
75	

2. Corner Radius
<b>Metric (mm)</b>
005 = 0.05 mm
01 = 0.10 mm
02 = 0.20 mm
03 = 0.30 mm
04 = 0.40 mm
06 = 0.60 mm
08 = 0.80 mm
12 = 1.20 mm
16 = 1.60 mm
20 = 2.00 mm
24 = 2.40 mm

3. Tolerance Group		
	<b>Metric (mm)</b>	
	Length of edge	±0.025
<b>G</b>	IC	±0.025
	Thickness	±0.13
	Length of edge	±0.08-0.15*
<b>M</b>	IC	±0.05-0.10*
	Thickness	±0.13
	Length of edge	±0.013
<b>F</b>	IC	±0.005
	Thickness	±0.025
	Length of edge	±0.13
<b>C</b>	IC	±0.025
	Thickness	±0.025
*Varies upon insert size		

4. Machining Direction
N = Neutral
L = Left
R = Right

5. Geometry						
Carbide	Carbide	Tangential	Ceramic	PCD	CBN	
108	155	880	711	530	538	
109	158	811		720	741	
112	161			730	742	
114	161			735	745	
117	174W				747	
121	192				748	
122	199				749	
126	200				768	
127	650					
128	711					
129	840					
145	850					
	860					

6./7. Optional Information
<b>W</b> = Wiper Geometry
<b>D</b> = Double Tipped
<b>T</b> = Triple Tipped



## ISO Insert Nomenclature

### DIN ISO 1832

<b>C</b>	<b>C</b>	<b>M</b>	<b>T</b>	<b>09</b>	<b>T3</b>	<b>02</b>
1	2	3	4	5	6	7

1. Basic Insert Form	2. Clearance Angle	3. Tolerance Group	4. Mounting Style										
<p><b>C</b> = Rhomboid 80°</p> <p><b>D</b> = Rhomboid 55°</p> <p><b>L</b> = Rectangular</p> <p><b>R</b> = Round</p> <p><b>S</b> = Square</p> <p><b>T</b> = Triangular</p> <p><b>V</b> = Rhomboid 35°</p> <p><b>W</b> = Trigon</p>	<p><b>B</b> = 5°</p> <p><b>C</b> = 7°</p> <p><b>N</b> = 0°</p> <p><b>P</b> = 11°</p> <p><b>O</b> = 10°</p>	<p><b>Metric (mm)</b></p> <p>Length of edge ±0.025</p> <p><b>G</b> IC ±0.025</p> <p>Thickness ±0.13</p> <hr/> <p>Length of edge ±0.08-0.15*</p> <p><b>M</b> IC ±0.05-0.10*</p> <p>Thickness ±0.13</p> <hr/> <p>Length of edge ±0.013</p> <p><b>F</b> IC ±0.005</p> <p>Thickness ±0.025</p> <hr/> <p>Length of edge ±0.13</p> <p><b>C</b> IC ±0.025</p> <p>Thickness ±0.025</p> <p>*Varies upon insert size</p>	<table border="1"> <tr> <td><b>T</b> = One-sided countersunk</td> <td>Cylindrical fixing hole Countersunk 40° - 60°</td> </tr> <tr> <td><b>H</b> = One-sided chipbreaker</td> <td>Cylindrical fixing hole Countersunk 70° - 90°</td> </tr> <tr> <td><b>W</b> = Without chipbreaker</td> <td>Cylindrical fixing hole Countersunk 40° - 60°</td> </tr> <tr> <td><b>X</b> = Special design</td> <td>Special insert design</td> </tr> <tr> <td><b>A</b> = Without chipbreaker</td> <td>Cylindrical fixing hole Without countersunk</td> </tr> </table>	<b>T</b> = One-sided countersunk	Cylindrical fixing hole Countersunk 40° - 60°	<b>H</b> = One-sided chipbreaker	Cylindrical fixing hole Countersunk 70° - 90°	<b>W</b> = Without chipbreaker	Cylindrical fixing hole Countersunk 40° - 60°	<b>X</b> = Special design	Special insert design	<b>A</b> = Without chipbreaker	Cylindrical fixing hole Without countersunk
<b>T</b> = One-sided countersunk	Cylindrical fixing hole Countersunk 40° - 60°												
<b>H</b> = One-sided chipbreaker	Cylindrical fixing hole Countersunk 70° - 90°												
<b>W</b> = Without chipbreaker	Cylindrical fixing hole Countersunk 40° - 60°												
<b>X</b> = Special design	Special insert design												
<b>A</b> = Without chipbreaker	Cylindrical fixing hole Without countersunk												

5. Insert Size / Cutting Edge							
Metric (mm)	C	D	R	S	T	V	W
3.97 mm					006		03
5.00 mm					F20		
6.00 mm					F21		
6.35 mm	06				11	11	
7.94 mm				07			
9.52 mm	09	11		09	16	16	
10.00 mm		10					
12.00 mm	12	12					
12.70 mm	16	15		12			
15.87 mm			15	15			
16.00 mm			16				
19.05 mm		19		19			
20.00 mm			20				
25.00 mm			25				
25.40 mm				25			

6. Insert Thickness
<b>Metric (mm)</b>
<b>01</b> = 1.59 mm
<b>02</b> = 2.38 mm
<b>T2</b> = 2.78 mm
<b>03</b> = 3.18 mm
<b>T3</b> = 3.97 mm
<b>04</b> = 4.76 mm
<b>05</b> = 5.56 mm
<b>06</b> = 6.35 mm
<b>07</b> = 7.94 mm

7. Corner Radius
<b>Metric (mm)</b>
<b>005</b> = 0.05 mm
<b>01</b> = 0.10 mm
<b>02</b> = 0.20 mm
<b>03</b> = 0.30 mm
<b>04</b> = 0.40 mm
<b>06</b> = 0.60 mm
<b>08</b> = 0.80 mm
<b>12</b> = 1.20 mm
<b>16</b> = 1.60 mm
<b>20</b> = 2.00 mm
<b>24</b> = 2.40 mm

## Wohlhaupter Insert Grades

### Uncoated Carbides

#### Uncoated Carbides

Cutting Material	Description	Material	ISO Application							
			05	10	15	20	25	30	35	40
WHW01 (HW)	<ul style="list-style-type: none"> <li>Fine-grain carbide</li> <li>Finishing and light roughing</li> <li>Nonferrous metals, cast materials and difficult-to-machine alloys</li> </ul>	P								
		M								
		K								
		N								
		S								
		H								
WHW16 (HW)	<ul style="list-style-type: none"> <li>Fine-grain carbide</li> <li>Finishing and light roughing</li> <li>Nonferrous metals, cast materials and difficult-to-machine alloys</li> </ul>	P								
		M								
		K								
		N								
		S								
		H								
WHW20 (HW)	<ul style="list-style-type: none"> <li>Tough fine-grain carbide</li> <li>Finishing, roughing and grooving</li> <li>Steel and cast materials, cast steel</li> <li>Nonferrous materials and difficult-to-machine alloys</li> </ul>	P								
		M								
		K								
		N								
		S								
		H								



## Wohlhaupter Insert Grades

### Coated Carbides

#### Coated Carbides

Cutting Material	Description	Material	ISO Application							
			05	10	15	20	25	30	35	40
WHC05 (HC)	<ul style="list-style-type: none"> <li>PVD coating with nano-composite structure</li> <li>Finishing and roughing</li> <li>Steels, stainless steels, cast materials, and difficult-to-machine alloys</li> </ul>	P								
		M								
		K								
		N								
		S								
		H								
WHC18 (HC)	<ul style="list-style-type: none"> <li>PVD-TiB2 coating</li> <li>Finishing and light roughing</li> <li>Nonferrous metals</li> </ul>	P								
		M								
		K								
		N								
		S								
		H								
WHC19 (HC)	<ul style="list-style-type: none"> <li>Multilayer PVD coating</li> <li>Finishing and roughing</li> <li>Stainless steels</li> </ul>	P								
		M								
		K								
		N								
		S								
		H								
WHC20 (HC)	<ul style="list-style-type: none"> <li>Multilayer CVD coating</li> <li>Finishing</li> <li>Steels and stainless steels</li> </ul>	P								
		M								
		K								
		N								
		S								
		H								
WHC30 (HC)	<ul style="list-style-type: none"> <li>CVD coating</li> <li>Roughing</li> <li>Steel and cast steel</li> </ul>	P								
		M								
		K								
		N								
		S								
		H								
WHC77 (HC)	<ul style="list-style-type: none"> <li>Fine-grained substrate with modified cobalt to increase strength</li> <li>MT-CVD coating combines advantages of TiCN and Al<sub>2</sub>O<sub>3</sub></li> <li>Versatile material designed for turning gray and ductile iron</li> <li>Rough and finish machining</li> <li>Medium to high cutting speeds</li> <li>Continuous and light to medium interrupted cuts</li> </ul>	P								
		M								
		K								
		N								
		S								
		H								
WHC79 (HC)	<ul style="list-style-type: none"> <li>Multilayer MT CVD coating</li> <li>Roughing and finishing</li> <li>Steels, stainless steels and cast materials</li> </ul>	P								
		M								
		K								
		N								
		S								
		H								
WHC81 (HC)	<ul style="list-style-type: none"> <li>Thick MT CVD coating with adominal AL203</li> <li>High cutting speeds possible</li> <li>Excellent choice for cast materials</li> </ul>	P								
		M								
		K								
		N								
		S								
		H								
WHC88 (HC)	<ul style="list-style-type: none"> <li>Multilayer PVD coating</li> <li>Finishing &amp; roughing</li> <li>Universal usage</li> </ul>	P								
		M								
		K								
		N								
		S								
		H								

A  
B  
C  
D  
E  
F  
G  
H  
I  
J  
K  
L  
M  
INDEX

## Wohlhaupter Insert Grades

### Coated Carbides

#### Coated Carbides

Cutting Material	Description	Material	ISO Application							
			05	10	15	20	25	30	35	40
WHC98 (HC)	<ul style="list-style-type: none"> <li>PVD TiAlN coating</li> <li>Roughing &amp; finishing</li> <li>Steels, stainless steels &amp; difficult-to-machine materials</li> </ul>	P								
		M								
		K								
		N								
		S								
WHC111 (HC)	<ul style="list-style-type: none"> <li>PVD TiAlN coating</li> <li>Finishing</li> <li>Machining of steels after heat treating with high Cr content up to 60 HRC</li> <li>Hard - soft transitions, difficult-to-machine alloys and stainless steels</li> </ul>	P								
		M								
		K								
		N								
		S								
WHC114 (HC)	<ul style="list-style-type: none"> <li>Multilayer PVD coating</li> <li>Finishing and roughing</li> <li>Steels, stainless steels, and difficult-to-machine materials</li> </ul>	P								
		M								
		K								
		N								
		S								
WHC136 (HC)	<ul style="list-style-type: none"> <li>Stronger PVD coating with improved coating adhesion</li> <li>High oxidation resistance allows a wide range of applications</li> </ul>	P								
		M								
		K								
		N								
		S								
WHC164 (HC)	<ul style="list-style-type: none"> <li>Thick MT-CVD coating with a dominant AC<sub>2</sub>O<sub>3</sub></li> <li>Primarily developed for the material groups P-K and alternatively H</li> <li>Full and discontinuous cut</li> <li>High cutting speeds possible</li> </ul>	P								
		M								
		K								
		N								
		S								
WHC168 (HC)	<ul style="list-style-type: none"> <li>Multilayer MT CVD coating</li> <li>Excellent combination of toughness and reliability</li> <li>Steels, cast materials and alternatively for stainless steel</li> </ul>	P								
		M								
		K								
		N								
		S								
WHC170 (HC)	<ul style="list-style-type: none"> <li>Multilayer MT CVD coating</li> <li>Excellent toughness</li> <li>First choice for strong interruptions</li> <li>Cast materials and steel</li> </ul>	P								
		M								
		K								
		N								
		S								
WHC198 (HC)	<ul style="list-style-type: none"> <li>Upgraded PVD grade with hard AlTiN coating</li> <li>Optimized cutting edge stability</li> <li>General machining of steel, stainless steel, high-temperature resistant alloys, titanium, iron, cast iron, and Nonferrous materials</li> </ul>	P								
		M								
		K								
		N								
		S								
WHC190 (HC)	<ul style="list-style-type: none"> <li>Newest generation multilayer PVD coating</li> <li>Finishing and roughing</li> <li>Extremely universal and the first choice for poor machining conditions</li> <li>Excellent in cast steels, stainless steels, and super alloys</li> </ul>	P								
		M								
		K								
		N								
		S								

## Wohlhaupter Insert Grades

Uncoated Cermet | Coated Cermet

### Uncoated Cermet

Cutting Material	Description	Material	ISO Application							
			05	10	15	20	25	30	35	40
WHT10 (HT)	<ul style="list-style-type: none"> <li>Uncoated cermet</li> <li>Finishing</li> <li>Steels, stainless steels and cast materials</li> </ul>	P								
		M								
		K								
		N								
		S								
		H								
WHT12 (HC)	<ul style="list-style-type: none"> <li>Uncoated cermet</li> <li>Finishing</li> <li>Steels, cast materials, sintered metals, and Nonferrous metals</li> </ul>	P								
		M								
		K								
		N								
		S								
		H								
WHT32 (HC)	<ul style="list-style-type: none"> <li>Uncoated cermet</li> <li>Finishing</li> <li>Steels and cast materials</li> </ul>	P								
		M								
		K								
		N								
		S								
		H								

### Coated Cermet

Cutting Material	Description	Material	ISO Application							
			05	10	15	20	25	30	35	40
WTC15 (TC)	<ul style="list-style-type: none"> <li>New PVD brilliant coating</li> <li>Reduce friction coefficient in turning applications</li> <li>Coated cermet general purpose grade for material group</li> <li>Achieves excellent surface finish with excellent wear resistance</li> <li>Usable in stainless steels</li> </ul>	P								
		M								
		K								
		N								
		S								
		H								
WTC121 (TC)	<ul style="list-style-type: none"> <li>PVD coated cermet</li> <li>Finishing of steels and stainless steels</li> </ul>	P								
		M								
		K								
		N								
		S								
		H								

A  
B  
C  
D  
E  
F  
G  
H  
I  
J  
K  
L  
M  
INDEX

## Wohlhaupter Insert Grades

Uncoated Cubic Boron Nitride | Coated Cubic Boron Nitride

### Uncoated Cubic Boron Nitride

Cutting Material	Description	Material	ISO Application							
			05	10	15	20	25	30	35	40
WBN150 (BN)	<ul style="list-style-type: none"> <li>Uncoated CBN grade</li> <li>Roughing and finishing smooth and slightly discontinuous cuts</li> <li>Hardened steels 52 - 64 HRC</li> <li>Grain size 2 µm</li> <li>CBN content: 50%</li> </ul>	P								
		M								
		K								
		N								
		S								
		H								
WBN200 (BN)	<ul style="list-style-type: none"> <li>Uncoated CBN grade</li> <li>Roughing and finishing highly discontinuous cuts</li> <li>Hardened steels 52 - 64 HRC</li> <li>Grain size 3 µm</li> <li>CBN content: 65%</li> </ul>	P								
		M								
		K								
		N								
		S								
		H								
WBN300 (BN)	<ul style="list-style-type: none"> <li>Uncoated CBN grade</li> <li>Roughing and finishing smooth cuts</li> <li>Hardened steels 52 - 64 HRC</li> <li>Grain size 0.5 - 1.0 µm</li> <li>CBN content: approximately 50%</li> </ul>	P								
		M								
		K								
		N								
		S								
		H								
WBN450 (BN)	<ul style="list-style-type: none"> <li>Uncoated CBN grade</li> <li>Roughing and finishing smooth and discontinuous cuts</li> <li>Pearlite grey cast iron and sintered metals</li> <li>Grain size 2 µm</li> <li>CBN content: 90%</li> </ul>	P								
		M								
		K								
		N								
		S								
		H								
WBN448 (BN)	<ul style="list-style-type: none"> <li>Uncoated CBN grade</li> <li>Roughing &amp; finishing smooth &amp; discontinuous cuts</li> <li>Pearlite grey cast iron &amp; sintered metals and ductile iron</li> <li>CBN content: 90%</li> </ul>	P								
		M								
		K								
		N								
		S								
		H								

### Coated Cubic Boron Nitride

Cutting Material	Description	Material	ISO Application							
			05	10	15	20	25	30	35	40
WBC300 (BC)	<ul style="list-style-type: none"> <li>Coated CBN</li> <li>Roughing and finishing smooth cuts</li> <li>Hardened steels 52 - 64 HRC</li> <li>Grain size 1 µm</li> <li>CBN content: 50%</li> </ul>	P								
		M								
		K								
		N								
		S								
		H								

## Wohlhaupter Insert Grades

Polycrystalline Diamond | Ceramic Cutting Material

### Polycrystalline Diamond

Cutting Material	Description	Material	ISO Application							
			05	10	15	20	25	30	35	40
PCD D30 (DP)	<ul style="list-style-type: none"> <li>PCD medium grain grade</li> <li>Finishing</li> <li>Al alloys and Mg alloys up to 12% Si</li> <li>Grain size 10 µm</li> </ul>	P								
		M								
		K								
		N								
		S								
		H								
PCD D50 (DP)	<ul style="list-style-type: none"> <li>PCD mixed-grain grade</li> <li>Finishing</li> <li>CFRP, GRP, MMC, Al alloys over 12% Si</li> <li>Grain size 2 - 30 µm</li> </ul>	P								
		M								
		K								
		N								
		S								
		H								

### Ceramic Cutting Material











Cutting Material	Description	Material	ISO Application							
			05	10	15	20	25	30	35	40
WCN40 (CN)	<ul style="list-style-type: none"> <li>Uncoated silicon-nitride ceramic</li> <li>Roughing</li> <li>Pearlite grey cast iron</li> </ul>	P								
		M								
		K								
		N								
		S								
		H								

A  
B  
C  
D  
E  
F  
G  
H  
I  
J  
K  
L  
M  
INDEX

## Wohlhaupter Insert Geometries

Cermet | Carbide























Cermet | Carbide

Geometry	Description	Application	Available Form
108 	<ul style="list-style-type: none"> <li>Sintered chip breaker for higher feeds</li> <li>Suitable for highly discontinuous cuts</li> </ul>	▼▼▼ ▼	F101, F103, F104, F112, F113
109 	<ul style="list-style-type: none"> <li>Sintered geometry with V-shaped chip breaker for roughing and finishing</li> <li>Good chip control even for shallow depth of cut</li> </ul>	▼▼▼ ▼	F101, F103, F104
112 	<ul style="list-style-type: none"> <li>Sintered chip breaker</li> <li>Finishing and light roughing</li> </ul>	▼▼▼ ▼	F101, F03
121 	<ul style="list-style-type: none"> <li>Positive geometry with stable cutting edge</li> <li>Finishing in different material groups</li> <li>Good chip control</li> </ul>	▼▼▼	F20, F211
122 	<ul style="list-style-type: none"> <li>Sintered chip breaker</li> <li>Good chip control - even with long-chipping materials</li> </ul>	▼▼▼	F101, F103, F161
126 	<ul style="list-style-type: none"> <li>Sintered version with a wide range of applications</li> </ul>	▼	F105
127 	<ul style="list-style-type: none"> <li>Highly positive sintered geometry</li> <li>For Nonferrous metals and cast iron</li> </ul>	▼▼▼ ▼	F37, F39, F101, F103, F104, F112, F113
128 	<ul style="list-style-type: none"> <li>Highly positive sintered geometry</li> <li>Polished for finishing Nonferrous metals, cast iron, and steel</li> </ul>	▼▼▼	F20
129 	<ul style="list-style-type: none"> <li>Highly positive chip breaking geometry</li> <li>Polished for Nonferrous metals, cast iron, and steel</li> <li>Ideal for structural steel applications</li> </ul>	▼▼▼ ▼	F37, F39, F101, F103
145 	<ul style="list-style-type: none"> <li>Geometry for finishing in smooth and discontinuous cut</li> <li>Good chip control - even with long-chipping materials</li> </ul>	▼▼▼ ▼	F101, F103, F112, F113, F161
146 	<ul style="list-style-type: none"> <li>Positive geometry with stable cutting edge</li> <li>Universal usage for roughing, finishing and chamfering</li> </ul>	▼▼▼ ▼	F037, F039, F101, F103, F104, F112, F113,

## Wohlhaupter Insert Geometries

Cermet | Carbide

Cermet | Carbide

Geometry	Description	Application	Available Form
155 	<ul style="list-style-type: none"> <li>Positive sintered geometry</li> <li>Special cutting edge design in combination with the chip breaker design enables exceptional chip control even at shallow cutting depths and light feeds</li> </ul>		F20, F101, F103, F39
158 	<ul style="list-style-type: none"> <li>Stable sintered geometry for roughing and finishing with and without discontinuous cuts</li> </ul>		F101, F103, F104, F105, F113, F114, F163
174W 	<ul style="list-style-type: none"> <li>Wiper geometry for highly productive turning and boring</li> <li>Can be used with pitch angle 92° - 95°</li> <li>Good chip breaking properties even at lower feed rates</li> </ul>		F101, F103
192 	<ul style="list-style-type: none"> <li>Sintered version for a variety of applications</li> <li>Low cutting pressure because of sharp cutting edge prep</li> </ul>		F39, F101, F103, F104, F112, F113, F163, F161, F262, F264
199 	<ul style="list-style-type: none"> <li>Positive sintered geometry for wide variety of applications</li> <li>Special chip breaker allows chip control with different radial depth of cut</li> </ul>		F101, F103, F104, F112, F113
200 	<ul style="list-style-type: none"> <li>Highly positive sintered geometry</li> <li>Applicable for various material groups for low cutting pressure</li> </ul>		F39, F101, F103, F104, F264
650 	<ul style="list-style-type: none"> <li>Obliquely ground chip breaker reduces cutting forces</li> <li>Finishing and smooth interrupted cuts</li> </ul>		F20, F211
711 	<ul style="list-style-type: none"> <li>Negative geometry with 0 rake suitable for fine finishing and semi roughing</li> <li>Machined materials in groups K and H</li> <li>Continuous and moderately interrupted cut</li> </ul>		F101, F103, F104, F113, F163
840 	<ul style="list-style-type: none"> <li>Parallel ground chip breaker</li> <li>For finish operations with stable cutting edge</li> </ul>		F20
850 	<ul style="list-style-type: none"> <li>Parallel ground chip breaker</li> <li>Good chip control with short to medium feeds</li> </ul>		F161
860 	<ul style="list-style-type: none"> <li>Parallel ground chip breaker reduces cutting forces</li> <li>Stable for a wide range of applications</li> </ul>		F101, F103, F104, F105, F325



A  
B  
C  
D  
E  
F  
G  
H  
I  
J  
K  
L  
M  
INDEX



## Wohlhaupter Insert Geometries

Tangential | Ceramic

### Tangential

Geometry	Description	Application	Available Form
880 	<ul style="list-style-type: none"> <li>Large parallel ground chip breaker with 10° rake angle for reduced cutting force</li> </ul>	▼	F04, F05
811 	<ul style="list-style-type: none"> <li>Smooth geometry without additional ground chip breaker</li> <li>Reinforced cutting edges provide stability</li> <li>Excellent for cast materials</li> </ul>	▼	F05







### Ceramic

Geometry	Description	Application	Available Form
711 	<ul style="list-style-type: none"> <li>Smooth geometry with 0° rake angle</li> <li>High cutting edge stability particularly in discontinuous cuts</li> </ul>	▼	F75, F103, F104, F123











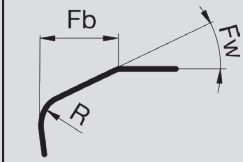



## Wohlhaupter Insert Geometries

PCD | CBN

### PCD

Geometry	Description	Application	Available Form
720 	<ul style="list-style-type: none"> <li>Smooth geometry in positive version with 7° rake angle for PCD</li> <li>Sharp cutting edge</li> </ul>		F20, F101, F103
730 	<ul style="list-style-type: none"> <li>Smooth geometry with 0° rake angle for PCD</li> <li>Sharp cutting edge</li> </ul>		F20, F39, F75, F101, F103, F123, F211, F262, F264
735 	<ul style="list-style-type: none"> <li>Smooth geometry</li> <li>Laser-cut chip breaker for PCD</li> <li>Suitable for long-chipping aluminum wrought alloys</li> </ul>		F20, F39, F101, F103, F211, F262, F264

### CBN

Geometry	Description				Application	Available Form
		R	Fb	Fw		
741 	<ul style="list-style-type: none"> <li>Smooth geometry with 0° rake angle for CBN</li> <li>Rounded cutting edge with 30° chamfer</li> </ul>	0.015	0.15	30°		F20, F101, F103
742 	<ul style="list-style-type: none"> <li>Smooth geometry with 0° rake angle for CBN</li> <li>Rounded cutting edge with 15° chamfer</li> </ul>	0.015	0.1	15°		F20, F101, F103
745 	<ul style="list-style-type: none"> <li>Smooth geometry with 0° rake angle for CBN</li> <li>Rounded cutting edge with 30° chamfer</li> </ul>	0.015	0.05	30°		F20, F211
747 	<ul style="list-style-type: none"> <li>Smooth geometry with 0° rake angle for CBN</li> <li>Rounded cutting edge with a small 20° chamfer</li> </ul>	0.015	0.1	20°		F39, F104, F262, F264
748 	<ul style="list-style-type: none"> <li>Smooth geometry with 0° rake angle for CBN</li> <li>Rounded cutting edge</li> <li>No chamfer</li> </ul>	0.015				F20, F101, F103, F211
749 	<ul style="list-style-type: none"> <li>Smooth geometry with 0° rake angle for CBN</li> <li>Rounded cutting edge with a large 20° chamfer</li> </ul>	0.015	0.2	20°		F75, F123, F264
768 	<ul style="list-style-type: none"> <li>Smooth geometry with 7° rake angle for CBN</li> <li>Rounded cutting edge</li> </ul>	0.015				F20, F101, F103

A

B

C

D

E

F

G

H

I

J

K

L

M

INDEX

# Insert Form 211

Cermet | Carbide

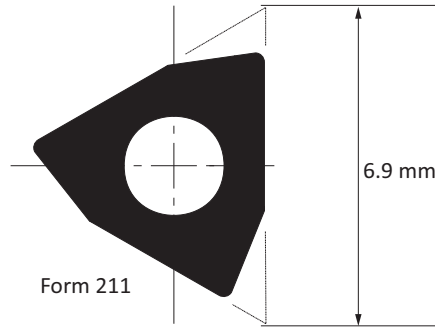

						Cermet					Carbide													
						Uncoated			Coated		Uncoated		Coated											
						WHT10	WHT12	WHT32	WTC15	WTC121	WHW01	WHW16	WHC05	WHC18	WHC19	WHC79	WHC98	WHC111	WHC114	WHC136	WHC164			
Geometry	Radius		Description	ISO Code	Part No.																			
	in	mm																						
Steel	P					▼▼							▼▼	▼▼				▼▼		▼▼				
Stainless Steel	M												▼▼	▼▼				▼▼		▼▼				
Cast Iron	K					▼▼						▼▼	▼▼	▼▼				▼▼		▼▼				
Nonferrous Materials	N					▼▼						▼▼		▼▼										
Titanium	S											▼▼		▼▼				▼▼		▼▼				
Hard Materials	H																	▼▼						
121	0.004	0.10	F21101GN121	WBGX030101	397675										⚙			⚙						
121	0.008	0.20	F21102GN121	WBGX030102	397676										⚙			⚙						
650	0.004	0.10	F21101GL650	WBGX030101	097755		●				●		●	●							●			
650	0.008	0.20	F21102GL650	WBGX030102	097454		●				●		●								●			

Reference Key

Symbol	Machining Conditions
●	Good - Main Application
⚙	Average - Main Application
⚙	Difficult - Main Application

Reference Key

Symbol	Insert Type
▼▼	Finishing - Main Application
▼▼	Finishing - Extended Application

Insert Form	Countersunk Screw		Torque Driver	Service Key	Technical Data	
	Part No.	Size			Torque	Key Size
211	215377	M2 x 0.4 x 4	415507	115537	0.6 Nm	T6

# Insert Form 211

CBN | PCD



730 Geometry



735 Geometry



748 Geometry

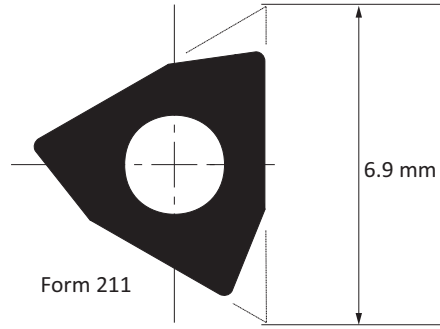

						Ceramic		CBN				PCD		
						Uncoated	Coated	Uncoated		Coated				
Steel						P								
Stainless Steel						M								
Cast Iron						K				▼▼▼				
Nonferrous Materials						N						▼▼▼▼▼		
Titanium						S								
Hard Materials						H			▼▼▼					
Geometry	Radius		Description	ISO Code	Part No.			WBN150	WBN200	WBN300	WBN450			
	in	mm								PKDD30	PKDD50			
730	0.004	0.10	F21101GN730	WBGX030101	397763								●	
730	0.008	0.20	F21102GN730	WBGX030102	097557								● ●	
735	0.008	0.20	F21102GN735	WBGX030102	397237								● ●	
748	0.004	0.10	F21101GN748	WBGX030101	097486			●		●			●	
748	0.008	0.20	F21102GN748	WBGX030102	097552			●		●			●	

Insert Form	Countersunk Screw		Torque Driver	Service Key	Technical Data	
					Torque	Key Size
211	215377	M2 x 0.4 x 4	415507	115537	0.6 Nm	T6

Reference Key

Symbol	Machining Conditions
●	Average - Main Application

Reference Key

Symbol	Insert Type
▼▼▼	Finishing - Main Application

A  
B  
C  
D  
E  
F  
G  
H  
I  
J  
K  
L  
M  
INDEX

### Insert Form 20

Cermet | Carbide

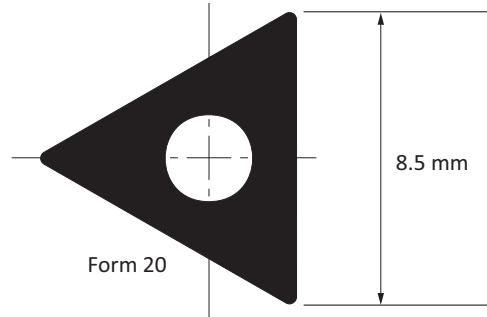

						Cermet					Carbide									
						Uncoated			Coated		Uncoated			Coated						
						WHT10	WHT12	WHT32	WTC15	WTC121	WHW01	WHW16	WHC05	WHC18	WHC19	WHC79	WHC98	WHC111	WHC114	WHC136
Geometry	Radius		Description	ISO Code	Part No.															
	in	mm																		
Steel	P																			
Stainless Steel	M																			
Cast Iron	K																			
Nonferrous Materials	N																			
Titanium	S																			
Hard Materials	H																			
121	0.004	0.10	F02001GN121	TOGX080201	397672															
121	0.008	0.20	F02002GN121	TOGX080202	397673															
121	0.016	0.40	F02004GN121	TOGX080204	397674															
121W	0.008	0.20	F02002GX121W	TOGX080202	397916															
121W	0.016	0.40	F02004GX121W	TOGX080204	397917															
128	0.004	0.10	F02001GN128	TOGX080201	297473															
128	0.008	0.20	F02002GN128	TOGX080202	297541															
128	0.016	0.40	F02004GN128	TOGX080204	297542															
155	0.008	0.20	F02002MN155	TOMX080202	397688															
155	0.016	0.40	F02004MN155	TOMX080204	397689															
650	0.004	0.10	F02001GL650	TOGX080201	097153															
650	0.008	0.20	F02002GL650	TOGX080202	097546															
650	0.012	0.30	F02003GL650	TOGX080203	097154															
650	0.016	0.40	F02004GL650	TOGX080204	097599															
650	0.031	0.80	F02008GL650	TOGX080208	397764															
840	0.008	0.20	F02002GR840	TOGX080202	097701															

Reference Key

Symbol	Machining Conditions
●	Good - Main Application
◐	Average - Main Application
⚙	Difficult - Main Application

Reference Key

Symbol	Insert Type
▼▼	Finishing - Main Application
▽▽	Finishing - Extended Application



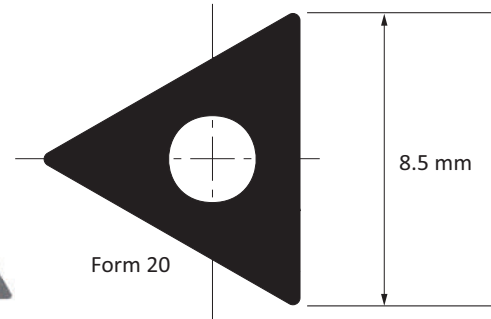
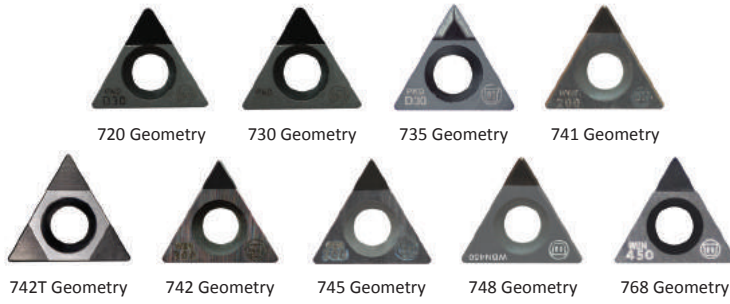

Insert Form	Countersunk Screw		Torque Driver	Service Key	Technical Data	
					Torque	Key Size
20	115535	M2 x 0.4 x 5	415508	115591	0.9 Nm	T7

# Insert Form 20

CBN | PCD



						CBN					PCD		
						Uncoated			Coated				
						WBNC150	WBNC200	WBNC300	WBNC450	WBNC448	WBNC300	PKDD30	PKDD50
Geometry	Radius		Description	ISO Code	Part No.								
	in	mm											
Steel													
Stainless Steel													
Cast Iron						▼▼▼	▼▼▼	▼▼▼					
Nonferrous Materials											▼▼▼	▼▼▼	
Titanium													
Hard Materials							▼▼▼	▼▼▼		▼▼▼			
720	0.008	0.20	F02002GN720	TOGX080202	297692							●	
720	0.016	0.40	F02004GN720	TOGX080204	297845							●	
730	0.008	0.20	F02002GN730	TOGX080202	097487							●	●
730	0.016	0.40	F02004GN730	TOGX080204	097686							●	●
730	0.031	0.80	F02008GN730	TOGX080208	097877							●	●
735	0.008	0.20	F02002GN735	TOGX080202	397133							●	
735	0.016	0.40	F02004GN735	TOGX080204	397301							●	
741	0.008	0.20	F02002GN741	TOGX080202	297260		●						
741	0.016	0.40	F02004GN741	TOGX080204	297262		●						
742	0.008	0.20	F02002GN742	TOGX080202	297264			●					
742	0.016	0.40	F02004GN742	TOGX080204	397610			●					
742T	0.008	0.20	F02002GN742T	TOGX080202	397961				●	●			
742T	0.016	0.40	F02004GN742T	TOGX080204	397551				●	●			
745	0.004	0.10	F02001GN745	TOGX080201	297259		●						
748	0.008	0.20	F02002GN748	TOGX080202	297780				●				
748	0.016	0.40	F02004GN748	TOGX080204	297782				●				
768	0.008	0.20	F02002GN768	TOGX080202	397146				●				
768	0.016	0.40	F02004GN768	TOGX080204	397192				●				

				Technical Data	
Insert Form	Countersunk Screw	Torque Driver	Service Key	Torque	Key Size
20	115535 M2 x 0.4 x 5	415508	115591	0.9 Nm	T7

### Reference Key

Symbol	Machining Conditions
●	Good - Main Application
●	Average - Main Application

### Reference Key

Symbol	Insert Type
▼▼▼	Finishing - Main Application
▼▼▼	Finishing - Extended Application

A  
B  
C  
D  
E  
F  
G  
H  
I  
J  
K  
L  
M  
INDEX

## Insert Forms 161, 163

Cermet | Carbide

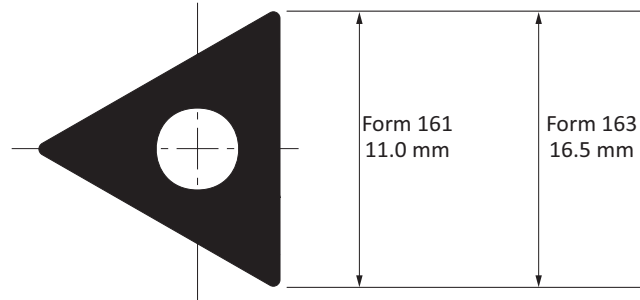

						Cermet					Carbide														
						Uncoated			Coated		Uncoated			Coated											
						WHT10	WHT12	WHT32	WTC15	WTC121	WHW01	WHW16	WHC05	WHC88	WHC190	WHC77	WHC79	WHC111	WHC114	WHC136	WHC164				
Geometry	Radius		Description	ISO Code	Part No.																				
	in	mm																							
122	0.016	0.40	F16104MN122	TCMT110204	097953	●																			
129	0.008	0.20	F16102GN129	TCGT110202	397769						●	●													
129	0.016	0.40	F16104GN129	TCGT110204	397770						●	●													
129	0.016	0.40	F16304GN129	TCGT16T304	397771						●	●													
145	0.016	0.40	F16104GN145	TCGT110204	297993													●							
146	0.016	0.40	F16104MN146	TCMT110204	397977									⚙											
146	0.031	0.80	F16108MN146	TCMT110208	397026									⚙											
146	0.016	0.40	F16304MN146	TCMT16T304	397990									⚙											
146	0.031	0.80	F16308MN146	TCMT16T308	397974									⚙											
158	0.016	0.40	F16304MN158	TCMT16T304	297604											●	●								
192	0.016	0.40	F16104MN192	TCMT110204	397663										⚙	●						●			
192	0.016	0.40	F16304MN192	TCMT16T304	397654										⚙							●			
192	0.031	0.80	F16308MN192	TCMT16T308	397772										⚙										
711	0.016	0.40	F16304MN711	TCMT16T304	397898											●									
711	0.031	0.80	F16304MN711	TCMT16T308	397899											●									
850	0.008	0.20	F16102GL850	TCGT110202	097512		●																		

### Reference Key

Symbol	Machining Conditions
●	Good - Main Application
●	Average - Main Application
⚙	Difficult - Main Application

### Reference Key

Symbol	Insert Type
▼▼	Finishing - Main Application
▽▽	Finishing - Extended Application

Insert Form	Countersunk Screw		Torque Driver	Service Key	Technical Data	
					Torque	Key Size
161	115676	M2.5 x 0.45 x 5	415514	115590	1.2 Nm	T8
163	115673	M3.5 x 0.6 x 9	415510	115664	3.0 Nm	T15



# Insert Form 47





Cermet | Carbide

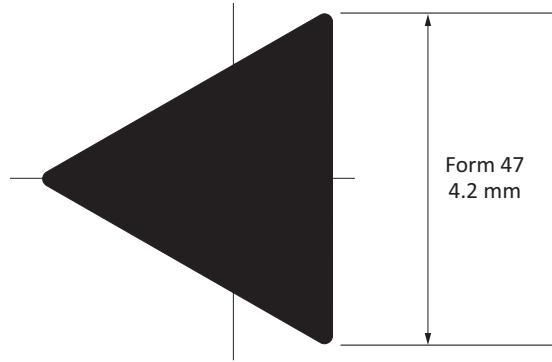

650 Geometry

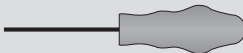

						Carbide									
						Uncoated					Coated				
Steel	P					▼▼▼									
Stainless Steel	M					▼▼▼									
Cast Iron	K	▼▼▼				▼▼▼									
Nonferrous Materials	N	▼▼▼													
Titanium	S	▼▼▼													
Hard Materials	H														
Geometry	Radius		ISO Code	Description	Part No.	WHW01	WHW16	WHC05	WHC18	WHC20	WHC79	WHC111	WHC114	WHC136	WHC164
	in	mm				●									
650	0.004	0.10	TOFX040101	F04701FL650	097832	●				●					
650	0.008	0.20	TOFX040102	F04702FL650	097833	●				●					

					Technical Data		
Insert Form	Countersunk Screw		Clamping Jaw	Torque Driver	Service Key	Torque	Key Size
47	315324	M1.8 x 0.35 x 4	315323	-	115537	0.5 Nm	T6

Reference Key

Symbol	Machining Conditions
●	Good - Main Application

Reference Key

Symbol	Insert Type
▼▼▼	Finishing - Main Application

A  
B  
C  
D  
E  
F  
G  
H  
I  
J  
K  
L  
M  
INDEX

### Insert Forms 101, 103, 104, 105

Cermet | Carbide

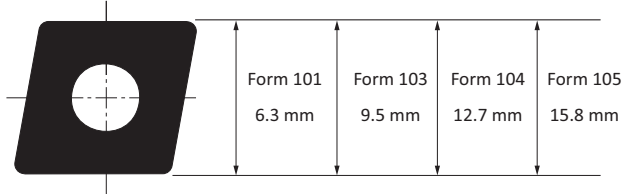
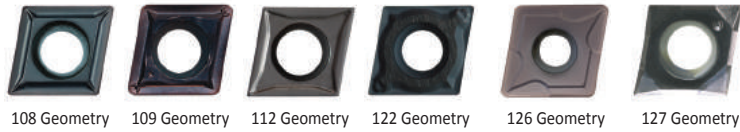

						Cermet						Carbide										
						Uncoated			Coated			Uncoated			Coated							
Steel P						▽▽▽			▽						▽▽▽			▽				
Stainless Steel M															▽▽▽			▽				
Cast Iron K						▽▽▽			▽▽▽			▽▽			▽▽▽			▽				
Nonferrous Materials N						▽▽▽			▽▽▽			▽▽	▽									
Titanium S												▽▽								▽▽		
Hard Materials H																						
Geometry	Radius		Description	ISO Description	Part No.	WHT10	WHT12	WHT16	WHT32	WTC15	WTC121	WHW01	WHW16	WHC05	WHC18	WHC19	WHC79	WHC98	WHC111	WHC114	WHC136	WHC164
	in	mm				WHT10	WHT12	WHT16	WHT32	WTC15	WTC121	WHW01	WHW16	WHC05	WHC18	WHC19	WHC79	WHC98	WHC111	WHC114	WHC136	WHC164
108	0.008	0.20	F10102MN108	CCMT060202	297833													●				
108	0.016	0.40	F10104MN108	CCMT060204	297537													●				
108	0.016	0.40	F10304MN108	CCMT09T304	297891													●				
108	0.031	0.80	F10308MN108	CCMT09T308	397118													●				
108	0.016	0.40	F10404MN108	CCMT120404	297725													●				
108	0.031	0.80	F10408MN108	CCMT120408	297724													●				
109	0.008	0.20	F10102MN109	CCMT060202	397352																	●
109	0.016	0.40	F10104MN109	CCMT060204	397765																	●
109	0.016	0.40	F10304MN109	CCMT09T304	397354																	●
109	0.031	0.80	F10308MN109	CCMT09T308	397355																	●
109	0.016	0.40	F10404MN109	CCMT120404	397356																	●
109	0.031	0.80	F10408MN109	CCMT120408	397357																	●
112	0.008	0.20	F10102GN112	CCGT060202	297485				●													
112	0.016	0.40	F10104MN112	CCMT060204	297434				●													
112	0.008	0.20	F10302GN112	CCGT09T302	297534				●													
112	0.016	0.40	F10304MN112	CCMT09T304	297387				●													
122	0.008	0.20	F10102MN122	CCMT060202	097899	●																
122	0.016	0.40	F10104MN122	CCMT060204	097926	●																
122	0.008	0.20	F10302MN122	CCMT09T302	097862	●																
122	0.016	0.40	F10304MN122	CCMT09T304	097957	●																
126	0.031	0.80	F10508MN126	CCMT160508	297557																	●
126	0.047	1.20	F10512MN126	CCMT160512	297558																	●
127	0.008	0.20	F10102GN127	CCGT060202	097529							●		●								
127	0.016	0.40	F10104GN127	CCGT060204	097445							●		●								
127	0.008	0.20	F10302GN127	CCGT09T302	297550							●		●								
127	0.016	0.40	F10304GN127	CCGT09T304	097497							●		●								
127	0.016	0.40	F10404GN127	CCGT120404	097496							●		●								

Reference Key

Symbol	Machining Conditions
●	Good - Main Application
●	Average - Main Application

Reference Key

Symbol	Insert Type
▽	Roughing - Main Application
▽	Roughing - Extended Application
▽▽▽	Finishing - Main Application
▽▽▽	Finishing - Extended Application

Insert Form	Countersunk Screw		Torque Driver	Service Key	Technical Data	
	Torque	Key Size				
101	115676	M2.5 x 0.45 x 5	415514	115590	1.2 Nm	T8
103	115672(<math>\lt; \phi 37\text{mm}</math>)	M3.5 x 0.6 x 7.5	415510	115664	3.0 Nm	T15
103	115673(>math>\gt; \phi 36\text{mm}</math>)	M3.5 x 0.6 x 9	415510	115664	3.0 Nm	T15
104	215149	M4.5 x 0.75 x 11.5	415543	215150	5.0 Nm	T20
105	215149	M4.5 x 0.75 x 11.5	415543	215150	5.0 Nm	T20

### Insert Forms 101, 103, 104, 105

Cermet | Carbide

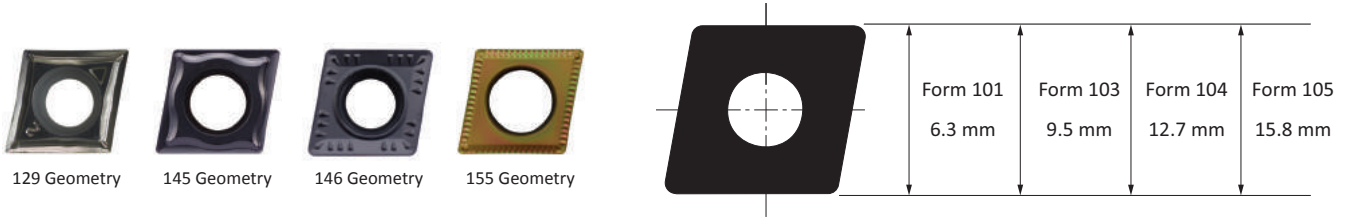

129 Geometry 145 Geometry 146 Geometry 155 Geometry

						Cermet				Carbide																	
						Uncoated		Coated		Uncoated		Coated															
						WHT10	WHT32	WTC15	WTC121	WHW01	WHW16	WHC05	WHC18	WHC19	WHC79	WHC81	WHC88	WHC98	WHC111	WHC114	WHC136	WHC164					
Geometry	Radius		Description	ISO Description	Part No.																						
	in	mm																									
Steel	P							▼▼▼			▼				▼▼▼	▼▼▼		▼▼▼									
Stainless Steel	M							▼▼▼			▼▼▼					▼▼▼	▼▼▼		▼▼▼								
Cast Iron	K							▼▼▼		▼▼▼	▼▼▼				▼▼▼	▼▼▼		▼▼▼									
Nonferrous Materials	N								▼▼▼	▼▼▼		▼▼▼															
Titanium	S								▼▼▼	▼▼▼		▼▼▼				▼▼▼	▼▼▼		▼▼▼								
Hard Materials	H														▼▼▼	▼▼▼		▼▼▼									
129	0.002	0.05	F101005GN129	CCGT0602005	397738					●	●																
129	0.004	0.10	F10101GN129	CCGT060201	397737					●	●																
129	0.008	0.20	F10102GN129	CCGT060202	297545					●	●	●															
129	0.016	0.40	F10104GN129	CCGT060204	297546					●	●	●															
129	0.008	0.20	F10302GN129	CCGT09T302	297547					●	●	●															
129	0.016	0.40	F10304GN129	CCGT09T304	297548					●	●	●															
145	0.016	0.40	F10104GN145	CCGT060204	297980															●							
145	0.031	0.80	F10108GN145	CCGT060208	397742															●							
145	0.016	0.40	F10304GN145	CCGT09T304	297994															●							
145	0.031	0.80	F10308GN145	CCGT09T308	297995															●							
146	0.016	0.40	F10104MN146	CCMT060204	397953											●	⚙										
146	0.016	0.40	F10304MN146	CCMT09T304	397142											●	⚙										
146	0.031	0.80	F10308MN146	CCMT09T308	397946											●	⚙										
146	0.016	0.40	F10404MN146	CCMT120404	397469												⚙										
146	0.031	0.80	F10408MN146	CCMT120408	397143												⚙										
146	0.047	1.20	F10412MN146	CCMT120412	397939												⚙										
155	0.008	0.20	F10102MN155	CCMT060202	397662																						
155	0.016	0.40	F10104MN155	CCMT060204	397739																						
155	0.016	0.40	F10304MN155	CCMT09T304	397740																						

Insert Form	Countersunk Screw		Torque Driver	Service Key	Technical Data	
					Torque	Key Size
101	115676	M2.5 x 0.45 x 5	415514	115590	1.2 Nm	T8
103	115672(<math>\phi</math>37mm)	M3.5 x 0.6 x 7.5	415510	115664	3.0 Nm	T15
103	115673(>math>\phi</math>36mm)	M3.5 x 0.6 x 9	415510	115664	3.0 Nm	T15
104	215149	M4.5 x 0.75 x 11.5	415543	215150	5.0 Nm	T20
105	215149	M4.5 x 0.75 x 11.5	415543	215150	5.0 Nm	T20

Reference Key

Symbol	Machining Conditions
●	Good - Main Application
◐	Average - Main Application

Reference Key

Symbol	Insert Type
▼	Roughing - Main Application
▽	Roughing - Extended Application
▼▼▼	Finishing - Main Application
▽▽▽	Finishing - Extended Application

# Insert Forms 101, 103, 104, 105

Carbide

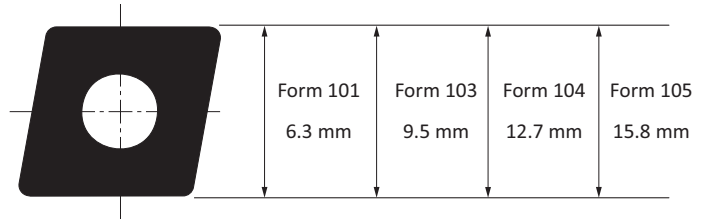

						Carbide										
						Uncoated				Coated						
						WHW01	WHW16	WHC05	WHC18	WHC19	WHC79	WHC98	WHC111	WHC114	WHC136	WHC164
Steel	P					▽▽▽				▽▽▽	▽▽▽		▽▽▽			▽▽▽
Stainless Steel	M					▽▽▽				▽▽▽	▽▽▽		▽▽▽			▽▽▽
Cast Iron	K					▽▽▽				▽▽▽	▽▽▽		▽▽▽			▽▽▽
Nonferrous Materials	N															
Titanium	S									▽▽▽			▽▽▽			
Hard Materials	H												▽▽▽			▽▽▽
Geometry	Radius		Description	ISO Code	Part No.	WHW01	WHW16	WHC05	WHC18	WHC19	WHC79	WHC98	WHC111	WHC114	WHC136	WHC164
	in	mm														
158	0.008	0.20	F10102MN158	CCMT060202	297248						●		●			
158	0.016	0.40	F10104MN158	CCMT060204	297377						●		●			
158	0.016	0.40	F10304MN158	CCMT09T304	297239						●		●			
158	0.031	0.80	F10308MN158	CCMT09T308	297240						●		●			
158	0.016	0.40	F10404MN158	CCMT120404	297242						●		●			
158	0.031	0.80	F10408MN158	CCMT120408	297241						●		●			
158	0.031	0.80	F10508MN158	CCMT160508	297559			●			●		●			
158	0.047	1.20	F10512MN158	CCMT160512	297560						●		●			
174W	0.016	0.40	F10104MN174W	CCMT060204	397766					⚙						●
174W	0.016	0.40	F10304MN174W	CCMT09T304	397767					⚙						●
174W	0.031	0.80	F10308MN174W	CCMT09T308	397768					⚙						●
192	0.008	0.20	F10102MN192	CCMT060202	297531					⚙						●
192	0.016	0.40	F10104MN192	CCMT060204	297658					⚙						●
192	0.031	0.80	F10108MN192	CCMT060208	297588					⚙						●
192	0.008	0.20	F10302MN192	CCMT09T302	297958					⚙						●
192	0.016	0.40	F10304MN192	CCMT09T304	297653					⚙						●
192	0.031	0.80	F10308MN192	CCMT09T308	397614					⚙						●
192	0.016	0.40	F10404MN192	CCMT120404	397666					⚙						●
192	0.031	0.80	F10408MN192	CCMT120408	297878					⚙						●
192	0.047	1.20	F10412MN192	CCMT120412	397632					⚙						●

### Reference Key

Symbol	Machining Conditions
●	Good - Main Application
◐	Average - Main Application
⚙	Difficult - Main Application

### Reference Key

Symbol	Insert Type
▽	Roughing - Main Application
▽▽	Roughing - Extended Application
▽▽▽	Finishing - Main Application
▽▽▽▽	Finishing - Extended Application

Insert Form	Countersunk Screw		Torque Driver		Service Key		Technical Data	
	Part No.	Size	Part No.	Part No.	Torque	Key Size		
101	115676	M2.5 x 0.45 x 5	415514	115590	1.2 Nm	T8		
103	115672(<math>\phi</math>37mm)	M3.5 x 0.6 x 7.5	415510	115664	3.0 Nm	T15		
103	115673(>math>\phi</math>36mm)	M3.5 x 0.6 x 9	415510	115664	3.0 Nm	T15		
104	215149	M4.5 x 0.75 x 11.5	415543	215150	5.0 Nm	T20		
105	215149	M4.5 x 0.75 x 11.5	415543	215150	5.0 Nm	T20		

# Insert Forms 101, 103, 104, 105

Cermet | Carbide

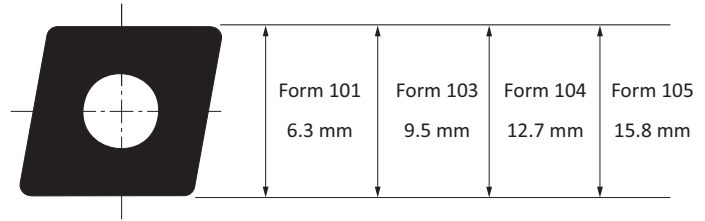
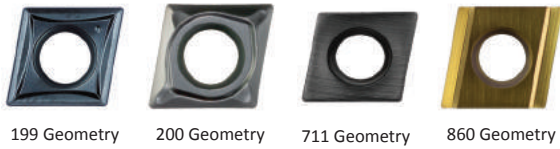

						Cermet						Carbide											
						Uncoated			Coated			Uncoated			Coated								
Material	ISO Code					WHT10	WHT12	WHT16	WHT32	WTC15	WTC121	WHW01	WHW16	WHC05	WHC18	WHC19	WHC77	WHC79	WHC98	WHC111	WHC114	WHC136	WHC164
Steel	P									▼▼▼			▼▼▼			▼▼▼			▼▼▼	▼▼▼	▼▼▼	▼▼▼	
Stainless Steel	M									▽▽▽			▽▽▽							▼▼▼	▼▼▼	▼▼▼	▼▼▼
Cast Iron	K									▽			▼▼▼			▼▼▼			▼▼▼	▼▼▼	▼▼▼	▼▼▼	▼▼▼
Nonferrous Materials	N									▼▼▼													
Titanium	S																			▼▼▼	▼▼▼	▼▼▼	▼▼▼
Hard Materials	H															▽▽▽				▼▼▼	▼▼▼	▼▼▼	▼▼▼
Geometry	Radius	Description	ISO Code	Part No.																			
	in	mm																					
199	0.008	0.20	F10102MN199	CCMT060202	397164																		
199	0.016	0.40	F10104MN199	CCMT060204	397165																		
199	0.008	0.20	F10302MN199	CCMT09T302	397702																		
199	0.016	0.40	F10304MN199	CCMT09T304	397166																		
199	0.031	0.80	F10308MN199	CCMT09T308	397167																		
199	0.016	0.40	F10404MN199	CCMT120404	397191																		
199	0.031	0.80	F10408MN199	CCMT120408	397168																		
200	0.008	0.20	F10102GN200	CCGT060202	397585																		
200	0.016	0.40	F10104GN200	CCGT060204	397586																		
200	0.008	0.20	F10302GN200	CCGT09T302	397587																		
200	0.016	0.40	F10304GN200	CCGT09T304	397588																		
200	0.016	0.40	F10404GN200	CCGT120404	397589																		
711	0.016	0.40	F10104MN711	CCMT060204	097637																		
711	0.016	0.40	F10304MN711	CCMT09T304	097692																		
711	0.031	0.80	F10308MN711	CCMT09T308	297910																		
711	0.031	0.80	F10408MN711	CCMT120408	297911																		
860	0.004	0.10	F10101GL860	CCGT060201	097324						●	●	●										●
860	0.008	0.20	F10102GL860	CCGT060202	097241						●	●	●										●
860	0.016	0.40	F10104GL860	CCGT060204	097242						●	●	●										●
860	0.008	0.20	F10302GL860	CCGT09T302	097245						●	●	●										●
860	0.016	0.40	F10304GL860	CCGT09T304	097244						●	●	●										●
860	0.016	0.40	F10404GL860	CCGT120404	097738						●	●	●										●
860	0.031	0.80	F10408GL860	CCGT120408	097247						●	●	●										●
860	0.031	0.80	F10508ML860	CCMT160508	097249						●	●	●										●

### Reference Key

Symbol	Machining Conditions
●	Good - Main Application
●	Average - Main Application

### Reference Key

Symbol	Insert Type
▼	Roughing - Main Application
▽	Roughing - Extended Application
▼▼▼	Finishing - Main Application
▽▽▽	Finishing - Extended Application

Insert Form	Countersunk Screw		Torque Driver		Service Key		Technical Data	
	Torque	Key Size	Torque	Key Size	Torque	Key Size	Torque	Key Size
101	115676	M2.5 x 0.45 x 5	415514	115590	1.2 Nm	T8		
103	115672(<math>\phi 37\text{mm}</math>)	M3.5 x 0.6 x 7.5	415510	115664	3.0 Nm	T15		
103	115673(>math>\phi 36\text{mm}</math>)	M3.5 x 0.6 x 9	415510	115664	3.0 Nm	T15		
104	215149	M4.5 x 0.75 x 11.5	415543	215150	5.0 Nm	T20		
105	215149	M4.5 x 0.75 x 11.5	415543	215150	5.0 Nm	T20		

### Insert Forms 101, 103, 104

Ceramic | CBN | PCD

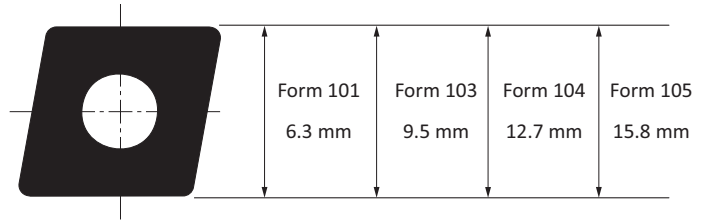
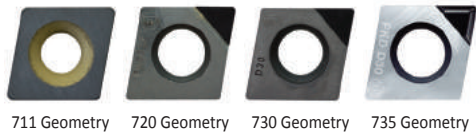

		Ceramic		CBN				PCD				
		Uncoated	Coated	Uncoated		Coated						
Steel	P											
Stainless Steel	M											
Cast Iron	K	▼			▼▼▼							
Nonferrous Materials	N						▼▼▼▼▼					
Titanium	S											
Hard Materials	H											
Geometry	Radius		Description	ISO Code	Part No.	WCN40	WBN150	WBN200	WBN300	WBN450	PKDD30	PKDD50
711	0.016	0.40	F10304GN711	CCGW09T304	297561	⚙️						
711	0.031	0.80	F10308GN711	CCGW09T308	297192	⚙️						
711	0.031	0.80	F10408GN711	CCGW120408	297249	⚙️						
711	0.047	1.20	F10412GN711	CCGW120412	297234	⚙️						
720	0.008	0.20	F10102GN720	CCGT060202	297501						⚙️	
720	0.016	0.40	F10104GN720	CCGT060204	297502						⚙️	
720	0.008	0.20	F10302GN720	CCGT09T302	297578						⚙️	
720	0.016	0.40	F10304GN720	CCGT09T304	297483						⚙️	
730	0.008	0.20	F10102GN730	CCGW060202	097462						⚙️	⚙️
730	0.016	0.40	F10104GN730	CCGW060204	297164						⚙️	⚙️
730	0.031	0.80	F10108GN730	CCGW060208	297165						⚙️	
730	0.008	0.20	F10302GN730	CCGW09T302	397251						⚙️	
730	0.016	0.40	F10304GN730	CCGW09T304	297533						⚙️	⚙️
730	0.016	0.40	F10404GN730	CCGW120404	397257						⚙️	⚙️
730	0.031	0.80	F10408GN730	CCGW120408	297871						⚙️	⚙️
735	0.008	0.20	F10102GN735	CCGT060202	297872						⚙️	
735	0.016	0.40	F10104GN735	CCGT060204	397244						⚙️	
735	0.008	0.20	F10302GN735	CCGT09T302	397252						⚙️	
735	0.016	0.40	F10304GN735	CCGT09T304	297870						⚙️	

Reference Key

Symbol	Machining Conditions
●	Good - Main Application
◐	Average - Main Application
⚙️	Difficult - Main Application

Reference Key

Symbol	Insert Type
▼	Roughing - Main Application
▽	Roughing - Extended Application
▼▼▼	Finishing - Main Application
▽▽▽	Finishing - Extended Application

Insert Form	Countersunk Screw		Torque Driver		Service Key		Technical Data	
	Part No.	Size	Part No.	Part No.	Torque	Key Size		
101	115676	M2.5 x 0.45 x 5	415514	115590	1.2 Nm	T8		
103	115672(<math>\phi</math>37mm)	M3.5 x 0.6 x 7.5	415510	115664	3.0 Nm	T15		
103	115673(>math>\phi</math>36mm)	M3.5 x 0.6 x 9	415510	115664	3.0 Nm	T15		
104	215149	M4.5 x 0.75 x 11.5	415543	215150	5.0 Nm	T20		

## Insert Forms 101, 103, 104

CBN

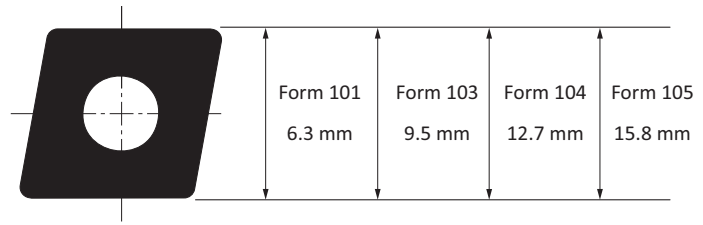
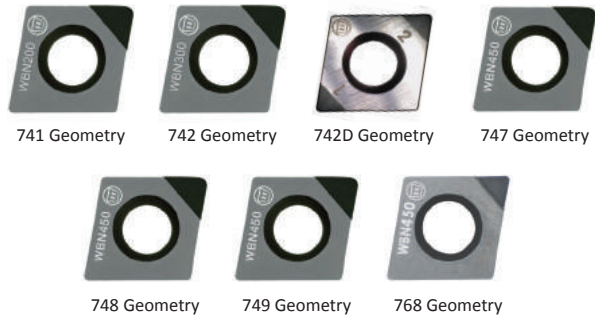

						CBN						
						Uncoated					Coated	
						WBN150	WBN200	WBN300	WBN450	WBN448	WBC300	
Geometry	Radius		Description	ISO Code	Part No.							
	in	mm										
Steel	P											
Stainless Steel	M											
Cast Iron	K					▽▽▽	▽	▽▽▽	▽▽▽	▽▽▽		
Nonferrous Materials	N											
Titanium	S											
Hard Materials	H					▽▽▽	▽▽▽	▽▽▽			▽▽▽	
741	0.008	0.20	F10102GN741	CCGW060202	297290							
741	0.016	0.40	F10104GN741	CCGW060204	297291		●					
741	0.016	0.40	F10304GN741	CCGW09T304	297303		●					
742	0.008	0.20	F10102GN742	CCGW060202	297293			●				
742	0.016	0.40	F10104GN742	CCGW060204	297294			●				
742	0.016	0.40	F10304GN742	CCGW09T304	297306			●				
742D	0.008	0.20	F10102GN742D	CCGW060202	397949					●	●	
742D	0.016	0.40	F10104GN742D	CCGW060204	397999					●	●	
742D	0.016	0.40	F10304GN742D	CCGW090204	397931					●	●	
742D	0.031	0.80	F10308GN742D	CCGW090208	397958					●	●	
747	0.016	0.40	F10404GN747	CCGW120404	397260	●			●			
748	0.008	0.20	F10102GN748	CCGW060202	297787				●			
748	0.016	0.40	F10104GN748	CCGW060204	297788				●			
748	0.008	0.20	F10302GN748	CCGW09T302	297790				●			
748	0.016	0.40	F10304GN748	CCGW09T304	297419				●			
749	0.031	0.80	F10408GN749	CCGW120408	397261	●			●			
768	0.008	0.20	F10102GN768	CCGT060202	297486				●			
768	0.016	0.40	F10104GN768	CCGT060204	297659				●			
768	0.008	0.20	F10302GN768	CCGT09T302	397439				●			
768	0.016	0.40	F10304GN768	CCGT09T304	297660				●			

### Reference Key

Symbol	Machining Conditions
●	Good - Main Application
●	Average - Main Application

### Reference Key

Symbol	Insert Type
▽	Roughing - Main Application
▽	Roughing - Extended Application
▽▽▽	Finishing - Main Application
▽▽▽	Finishing - Extended Application

Insert Form	Countersunk Screw		Torque Driver		Service Key		Technical Data	
	Torque	Key Size	Torque	Key Size	Torque	Key Size		
101	115676	M2.5 x 0.4 x 5	415514	115590	1.2 Nm	T8		
103	115672(<math>\phi 37\text{mm}</math>)	M3.5 x 0.6 x 7.5	415510	115664	3.0 Nm	T15		
103	115673(>math>\phi 36\text{mm}</math>)	M3.5 x 0.6 x 9	415510	115664	3.0 Nm	T15		
104	215149	M4.5 x 0.75 x 11.5	415543	215150	5.0 Nm	T20		



# Insert Form 37, 39

Cermet | Carbide

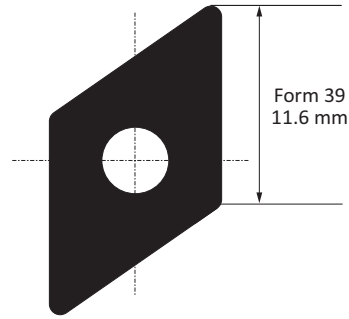
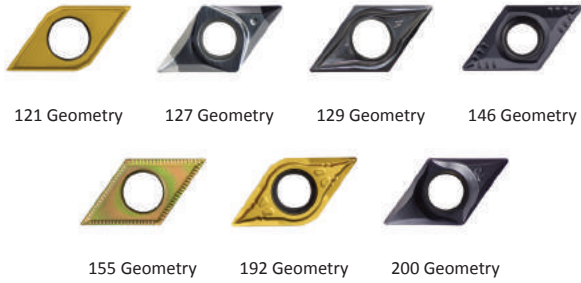

						Cermet						Carbide											
						Uncoated			Coated			Uncoated			Coated								
Steel									▼▼▼					▼▼▼	▼▼▼	▼▼▼	▼▼▼			▼▼▼	▼▼▼		
Stainless Steel									▽▽▽					▽▽▽		▼▼▼	▼▼▼			▼▼▼	▼▼▼		
Cast Iron									▽▽▽			▽▽▽	▼▼▼	▼▼▼		▼▼▼	▼▼▼			▼▼▼	▽▽▽		
Nonferrous Materials												▼▼▼											
Titanium												▽▽▽			▼▼▼	▼▼▼	▼▼▼			▼▼▼	▼▼▼		
Hard Materials															▽▽▽		▼▼▼			▽▽▽			
Geometry	Radius		Description	ISO Code	Part No.	WHT10	WHT12	WHT16	WHT32	WTC15	WTC121	WHW01	WHW16	WHC05	WHC81	WHC88	WHC98	WHC111	WHC114	WHC136	WHC164	WHC190	
	in	mm				WHT10	WHT12	WHT16	WHT32	WTC15	WTC121	WHW01	WHW16	WHC05	WHC81	WHC88	WHC98	WHC111	WHC114	WHC136	WHC164	WHC190	
121	0.008	0.20	F03902MN121	DCMT11T302	397787																	●	
121	0.016	0.40	F03904MN121	DCMT11T304	397788																		●
127	0.008	0.20	F03702GN127	DCGT070202	397234								●										
127	0.016	0.40	F03704GN127	DCGT070204	097787								●										
127	0.008	0.20	F03902GN127	DCGT11T302	397235								●										
127	0.016	0.40	F03904GN127	DCGT11T304	097559								●										
129	0.008	0.20	F03702GN129	DCGT070202	397708								●										
129	0.008	0.20	F03902GN129	DCGT11T302	397816								●	●									
129	0.016	0.40	F03904GN129	DCGT11T304	397817								●	●									
146	0.016	0.40	F03704MN146	DCMT070204	397968										●	●							
146	0.031	0.80	F03708MN146	DCMT070208	397047										●	●							
146	0.016	0.40	F03904MN146	DCMT11T304	397591										●	●							
146	0.031	0.80	F03908MN146	DCMT11T308	397598										●	●							
155	0.008	0.20	F03902MN155	DCMT11T302	397809					●													
155	0.016	0.40	F03904MN155	DCMT11T304	397810					●													
192	0.008	0.20	F03902MN192	DCMT11T302	397783																	●	●
192	0.016	0.40	F03904MN192	DCMT11T304	297721																	●	●
192	0.031	0.80	F03908MN192	DCMT11T308	397784																	●	●
200	0.008	0.20	F03902GN200	DCGT11T302	397785													●					
200	0.016	0.40	F03904GN200	DCGT11T304	397786													●					

Reference Key

Symbol	Machining Conditions
●	Good - Main Application
●	Average - Main Application
⚙	Difficult - Main Application

Reference Key

Symbol	Insert Type
▼	Roughing - Main Application
▽	Roughing - Extended Application
▼▼▼	Finishing - Main Application
▽▽▽	Finishing - Extended Application

Insert Form	Countersunk Screw		Torque Driver	Service Key	Technical Data	
	Part No.	Size	Part No.	Part No.	Torque	Key Size
39	115673	M3.5 x 0.6 x 9	414510	115664	3.0 Nm	T15

# Insert Form 37, 39

CBN | PCD



730 Geometry    735 Geometry    747 Geometry

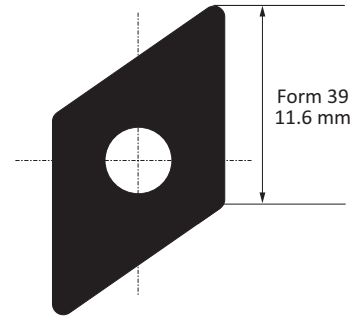

						CBN					PCD			
						Uncoated			Coated					
Steel		P												
Stainless Steel		M												
Cast Iron		K				▽▽▽			▽▽▽					
Nonferrous Materials		N										▽▽▽		
Titanium		S												
Hard Materials		H				▽▽▽								
Geometry	Radius		Description	ISO Code	Part No.	WBN150	WBN200	WBN300	WBN450	WBN200			PKDD30	PKDD50
	in	mm												
730	0.008	0.20	F03902GN730	DCGW11T302	397269								●	
730	0.016	0.40	F03904GN730	DCGW11T304	397270								●	
735	0.008	0.20	F03902GN735	DCGT11T302	397271								●	
735	0.016	0.40	F03904GN735	DCGT11T304	397272								●	
747	0.008	0.20	F03902GN747	DCGW11T302	397273	●			●					
747	0.016	0.40	F03904GN747	DCGW11T304	397274	●			●					

Reference Key

Symbol	Machining Conditions
●	Average - Main Application
⊕	Difficult - Main Application

Reference Key

Symbol	Insert Type
▽	Roughing - Main Application
▽	Roughing - Extended Application
▽▽▽	Finishing - Main Application
▽▽▽	Finishing - Extended Application

Insert Form	Countersunk Screw		Torque Driver	Service Key	Technical Data	
					Torque	Key Size
39	115673	M3.5 x 0.6 x 9	414510	115664	3.0 Nm	T15

A  
B  
C  
D  
E  
F  
G  
H  
I  
J  
K  
L  
M  
INDEX

### Insert Forms 112, 113, 114

Carbide

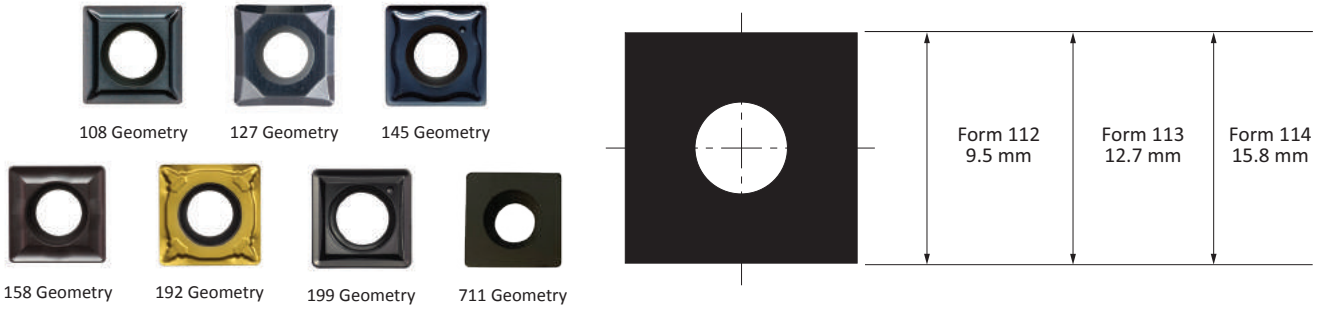

		Carbide																	
		Uncoated			Coated														
Material	Grade	WHW01	WHW16	WHC05	WHC30	WHC77	WHC79	WHC81	WHC88	WHC98	WHC111	WHC114	WHC136	WHC164	WHC190				
Steel	P				▽▽▽	▽▽	▽▽	▽▽	▽▽	▽▽	▽▽	▽▽	▽▽	▽▽	▽▽				
Stainless Steel	M				▽▽	▽	▽▽		▽▽	▽▽	▽▽	▽▽		▽▽	▽▽				
Cast Iron	K		▽▽		▽▽	▽▽	▽▽	▽▽		▽▽	▽▽	▽▽		▽▽	▽▽				
Nonferrous Materials	N		▽▽																
Titanium	S		▽▽		▽▽					▽▽	▽▽	▽▽		▽▽	▽▽				
Hard Materials	H					▽▽		▽▽			▽▽			▽▽					
Geometry	Radius		Description	ISO Code	Part No.	WHW01	WHW16	WHC05	WHC30	WHC77	WHC79	WHC81	WHC88	WHC98	WHC111	WHC114	WHC136	WHC164	WHC190
108	0.016	0.40	F11204MN108	SCMT09T304	297535									●					
108	0.031	0.80	F11308MN108	SCMT120408	397110									●					
127	0.016	0.40	F11204GN127	SCGT09T304	097539		●												
127	0.016	0.40	F11304GN127	SCGT120404	397590		●												
127	0.031	0.80	F11308GN127	SCGT120408	097566		●												
145	0.031	0.80	F11208GN145	SCGT09T308	297996										●				
145	0.031	0.80	F11308GN145	SCGT120408	297997										●				
146	0.016	0.40	F11204MN146	SCMT09T304	397940							●	⚙						
146	0.031	0.80	F11208MN146	SCMT09T308	397992							●	⚙						
146	0.016	0.40	F11304MN146	SCMT12T304	397049							●	⚙						
146	0.031	0.80	F11308MN146	SCMT12T308	397969							●	⚙						
158	0.031	0.80	F11308MN158	SCMT120408	297497					●									
158	0.047	1.20	F11412MN158	SCMT150512	097252				⚙										
192	0.016	0.40	F11204MN192	SCMT09T304	397741													●	⚙
192	0.031	0.80	F11208MN192	SCMT09T308	397640													●	⚙
192	0.031	0.80	F11308MN192	SCMT120408	397709													●	⚙
192	0.047	1.20	F11312MN192	SCMT120412	397710														⚙
199	0.016	0.40	F11204MN199	SCMT09T304	397703													●	
199	0.031	0.80	F11208MN199	SCMT09T308	397704													●	
199	0.031	0.80	F11308MN199	SCMT120408	397705													●	
711	0.031	0.80	F11308MN711	SCMT120408	297212					●									

Reference Key

Symbol	Machining Conditions
●	Good - Main Application
●	Average - Main Application
⚙	Difficult - Main Application

Reference Key

Symbol	Insert Type
▽	Roughing - Main Application
▽	Roughing - Extended Application
▽▽▽	Finishing - Extended Application

Insert Form	Countersunk Screw		Torque Driver		Service Key		Technical Data	
	Part No.	Dimensions	Part No.	Part No.	Torque	Key Size		
112	115672	(<Ø37mm)	M3.5 x 0.6 x 7.5	415510	115664	3.0 Nm	T15	
112	115673	(>Ø36mm)	M3.5 x 0.6 x 9	415510	115664	3.0 Nm	T15	
113	215149		M4.5 x 0.75 x 11.5	415543	215150	5.0 Nm	T20	
114	215149		M4.5 x 0.75 x 11.5	415543	215150	5.0 Nm	T20	

## Insert Forms 04, 05

Carbide

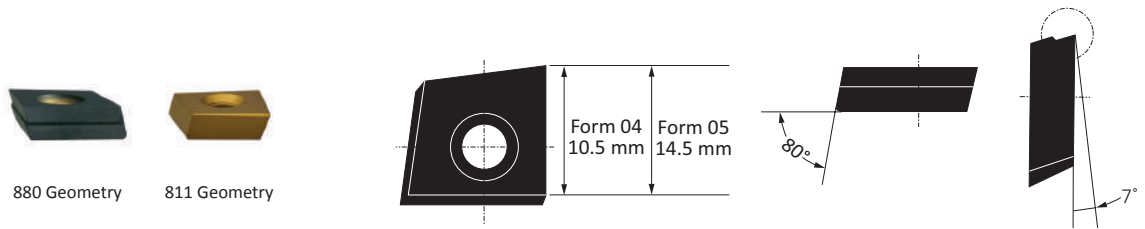

						Carbide											
						Uncoated					Coated						
						WHW16	WHC05	WHC18	WHC19	WHC79	WHC98	WHC111	WHC114	WHC170	WHC168	WHC198	
Steel	P														▼	▼	
Stainless Steel	M														▽	▼	
Cast Iron	K														▼	▼	
Nonferrous Materials	N															▽	
Titanium	S															▽	
Hard Materials	H																
Geometry	Radius		Description	ISO Code	Part No.	WHW16	WHC05	WHC18	WHC19	WHC79	WHC98	WHC111	WHC114	WHC170	WHC168	WHC198	
	in	mm															
880	0.016	0.40	F00404ML880	-	397595												●
880	0.016	0.40	F00504ML880	-	397593										⚙	⚙	●
880	0.031	0.80	F00508ML880	-	397594									⚙	⚙	⚙	●
811	0.031	0.80	F00508ML811	-	397844										⚙	⚙	●

Insert Form	Countersunk Screw		Torque Driver	Service Key	Technical Data	
					Torque	Key Size
04	415977	M4 x 0.7 x 7.9	415510	115664	3.0 Nm	T15
05	415949	M4 x 0.7 x 11	415543	215150	5.0 Nm	T20

### Reference Key

Symbol	Machining Conditions
●	Average - Main Application
⚙	Difficult - Main Application

### Reference Key

Symbol	Insert Type
▼	Roughing - Main Application
▽	Roughing - Extended Application

A  
B  
C  
D  
E  
F  
G  
H  
I  
J  
K  
L  
M  
INDEX

# Radial Grooving Insert Forms 89, 90, 91

Carbide

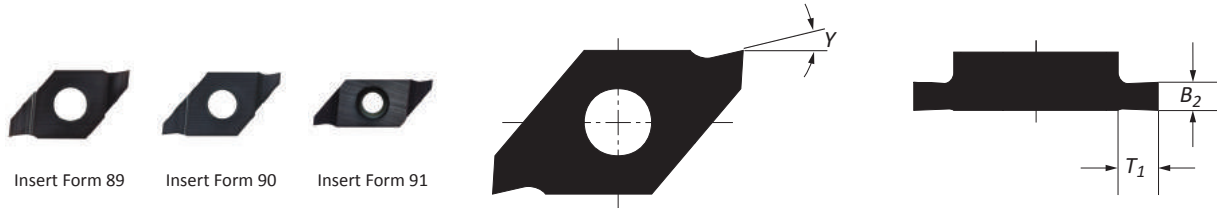

						Carbide												
						Uncoated			Coated									
Steel																		▼▼
Stainless Steel																		▽▽
Cast Iron								▽										▼▼
Nonferrous Materials								▼▼										
Titanium								▽										▼▼
Hard Materials																		
Insert Form	B <sub>2</sub>	Y	T <sub>1</sub>	Ring Width	Part No.	WHW01	WHW16	WHW20	WHC05	WHC18	WHC19	WHC79	WHC98	WHC111	WHC114	WHC136	WHC164	
89	0.048	13°	0.051	0.039	097257			●									●	
89	0.056	13°	0.051	0.047	097258			●									●	
89	0.068	13°	0.059	0.059	097259			●									●	
90	0.078	9°	0.094	0.068	097256			●									●	
90	0.090	9°	0.094	0.078	097253			●									●	
90	0.109	9°	0.094	0.098	097254			●									●	
90	0.129	9°	0.094	0.118	097255			●									●	
91	0.109	9°	0.094	0.098	097260			●									●	
91	0.129	9°	0.094	0.118	097261			●									●	
91	0.168	9°	0.129	0.157	097262			●									●	
91	0.208	9°	0.177	0.196	097294			●									●	
89	1.24	13°	1.30	1.00	097257			●									●	
89	1.44	13°	1.30	1.20	097258			●									●	
89	1.74	13°	1.50	1.50	097259			●									●	
90	1.99	9°	2.40	1.75	097256			●									●	
90	2.29	9°	2.40	2.00	097253			●									●	
90	2.79	9°	2.40	2.50	097254			●									●	
90	3.29	9°	2.40	3.00	097255			●									●	
91	2.79	9°	2.40	2.50	097260			●									●	
91	3.29	9°	2.40	3.00	097261			●									●	
91	4.29	9°	3.30	4.00	097262			●									●	
91	5.29	9°	4.50	5.00	097294			●									●	

Insert Form	Countersunk Screw		Torque Driver	Service Key	Technical Data	
					Torque	Key Size
89	115676	M2.5 x 0.45 x 5	415514	115590	1.2 Nm	T8
90	115531	M3 x 0.5 x 7.5	415514	115590	1.2 Nm	T8
91	115802	M3 x 0.5 x 12	415514	115590	1.2 Nm	T8

Reference Key

Symbol	Machining Conditions
●	Average - Main Application

Reference Key

Symbol	Insert Type
▼▼	Universal - Main Application
▽▽	Universal - Extended Application

# Radial Grooving Insert Forms 89, 90, 91

Carbide

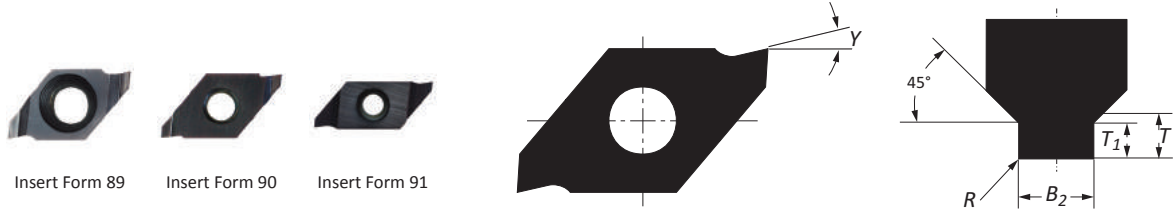

									Carbide													
									Uncoated						Coated							
									WHW01	WHW16	WHW20	WHC05	WHC18	WHC19	WHC79	WHC98	WHC111	WHC114	WHC136	WHC164		
Insert Form	Boring Ø	B <sub>2</sub>	Y	R	T <sub>1</sub>	T	Ring Width	Part No.														
Steel P																				▼▼		
Stainless Steel M																				▼▼		
Cast Iron K																				▼▼		
Nonferrous Materials N																						
Titanium S																				▼▼		
Hard Materials H																						
i	89	0.944 - 1.023	0.056	13°	0.004	0.021	0.025	0.047	297937													
	89	1.102 - 1.181	0.056	13°	0.004	0.025	0.029	0.047	297938												●	
	89	1.220 - 1.259	0.056	13°	0.004	0.030	0.035	0.047	297939												●	
	89	1.338	0.068	13°	0.004	0.030	0.035	0.059	297940												●	
	89	1.377 - 1.496	0.068	13°	0.004	0.036	0.041	0.059	297941												●	
	90	1.574 - 1.889	0.078	9°	0.006	0.046	0.051	0.068	297942												●	
	90	1.968 - 2.480	0.090	9°	0.006	0.056	0.062	0.078	297943												●	
	91	2.559 - 3.070	0.109	9°	0.008	0.056	0.062	0.098	297944												●	
	91	3.149 - 3.228	0.109	9°	0.008	0.066	0.072	0.098	297945												●	
	91	3.346 - 3.937	0.129	9°	0.008	0.066	0.072	0.118	297946												●	
91	4.015 - 5.708	0.168	9°	0.008	0.076	0.084	0.157	297947												●		
m	89	24.00 - 26.00	1.44	13°	0.10	0.54	0.65	1.20	297937												●	
	89	28.00 - 30.00	1.44	13°	0.10	0.64	0.75	1.20	297938												●	
	89	31.00 - 32.00	1.44	13°	0.10	0.78	0.91	1.20	297939												●	
	89	34.00	1.74	13°	0.10	0.78	0.91	1.50	297940												●	
	89	35.00 - 38.00	1.74	13°	0.10	0.93	1.06	1.50	297941												●	
	90	40.00 - 48.00	1.99	9°	0.15	1.18	1.31	1.75	297942												●	
	90	50.00 - 63.00	2.29	9°	0.15	1.43	1.58	2.00	297943												●	
	91	65.00 - 78.00	2.79	9°	0.20	1.43	1.58	2.50	297944												●	
	91	80.00 - 82.00	2.79	9°	0.20	1.68	1.84	2.50	297945												●	
	91	85.00 - 100.00	3.29	9°	0.20	1.68	1.84	3.00	297946												●	
91	102.00 - 145.00	4.29	9°	0.20	1.94	2.14	4.00	297947												●		

Insert Form	Countersunk Screw		Torque Driver	Service Key	Technical Data	
	Part No.	Dimensions			Torque	Key Size
89	115676	M2.5 x 0.45 x 5	415514	115590	1.2 Nm	T8
90	115531	M3 x 0.5 x 7.5	415514	115590	1.2 Nm	T8
91	115802	M3 x 0.5 x 12	415514	115590	1.2 Nm	T8

Reference Key

Symbol	Machining Conditions
●	Average - Main Application

Reference Key

Symbol	Insert Type
▼▼	Universal - Main Application
▼▼	Universal - Extended Application

# Axial Grooving Insert Blanks Form 304

Carbide



			Carbide											
			Uncoated			Coated								
Material	Code		WHW01	WHW16	WHW20	WHC05	WHC18	WHC19	WHC79	WHC98	WHC111	WHC114	WHC136	WHC164
Steel	P													
Stainless Steel	M													
Cast Iron Nonferrous Materials	K				▽▽									
Nonferrous Materials	N				▽▽									
Titanium	S				▽▽									
Hard Materials	H													
Geometry	S <sub>1</sub>	Part No.	WHW01	WHW16	WHW20	WHC05	WHC18	WHC19	WHC79	WHC98	WHC111	WHC114	WHC136	WHC164
	0.137	297150			●									
	0.169	297151			●									
	0.208	297152			●									
	0.255	297154			●									
	0.295	297493			●									
	0.137	397850			●									
	0.169	397851			●									
	0.208	397852			●									
	0.255	397853			●									
	0.295	397854			●									
	3.50	297150			●									
	4.30	297151			●									
	5.30	297152			●									
	6.50	297154			●									
	7.50	297493			●									
	3.50	397850			●									
	4.30	397851			●									
	5.30	397852			●									
	6.50	397853			●									
	7.50	397854			●									

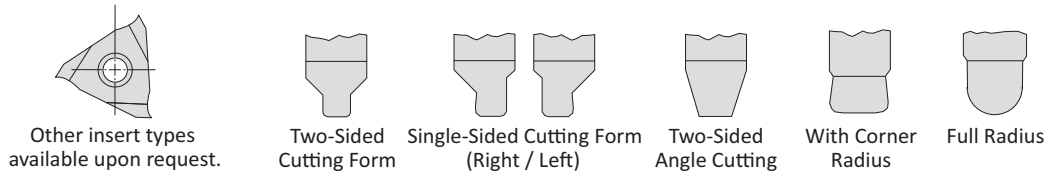

Reference Key

Symbol	Machining Conditions
●	Average - Main Application

Reference Key

Symbol	Insert Type
▽▽	Universal - Main Application
▽	Universal - Extended Application



Insert Form	Countersunk Screw	Torque Driver	Service Key	Technical Data	
304	215392 M5 x 0.8 x 12.9	415543	215150	Torque 5.0 Nm	Key Size T20





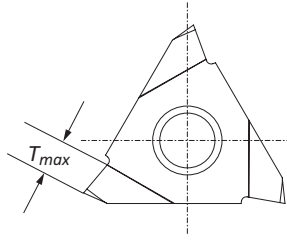

## Axial Grooving O-Rings for Single Cutter Tools Insert Form 304

Carbide



								Carbide											
								Uncoated			Coated								
								WHW01	WHW16	WHW20	WHC05	WHC18	WHC19	WHC79	WHC98	WHC111	WHC114	WHC136	WHC164
Steel		P																▼	
Stainless Steel		M																▽	
Cast Iron Nonferrous Materials		K																▼	
Nonferrous Materials		N																	
Titanium		S																▼	
Hard Materials		H																	
Geometry	Boring Range	O-Ring Cross Section	$B + 0.05$	$B_{max}$	$T_{max}$	$R \pm 0.05$	Part No.	WHW01	WHW16	WHW20	WHC05	WHC18	WHC19	WHC79	WHC98	WHC111	WHC114	WHC136	WHC164
	0.787 - 2.125	0.039	0.059	0.059	0.064	0.008	297969												
	0.787 - 2.125	0.059	0.086	0.086	0.092	0.012	297970												●
	0.787 - 2.125	0.078	0.114	0.114	0.124	0.016	297971												●
	0.787 - 2.125	0.098	0.137	0.137	0.151	0.020	297972												●
	0.787 - 2.125	0.118	0.161	0.161	0.175	0.024	297973												●
	0.787 - 2.125	0.157	0.212	0.212	0.194	0.031	297974												●
	0.787 - 2.125	0.196	0.267	0.267	0.194	0.031	297975												●
	20 - 54	1.00	1.50	1.50	1.65	0.20	297969												●
	20 - 54	1.50	2.20	2.20	2.35	0.30	297970												●
	20 - 54	2.00	2.90	2.90	3.15	0.40	297971												●
	20 - 54	2.50	3.50	3.50	3.85	0.50	297972												●
	20 - 54	3.00	4.10	4.10	4.45	0.60	297973												●
20 - 54	4.00	5.40	5.40	4.95	0.80	297974												●	
20 - 54	5.00	6.80	6.80	4.95	0.80	297975												●	

				Technical Data		
Insert Form	Countersunk Screw		Torque Driver	Service Key	Torque	Key Size
304	215392	M5 x 0.8 x 12.9	415543	215150	5.0 Nm	T20

Reference Key

Symbol	Machining Conditions
●	Average - Main Application

Reference Key

Symbol	Insert Type
▼	Universal - Main Application
▽	Universal - Extended Application

A  
B  
C  
D  
E  
F  
G  
H  
I  
J  
K  
L  
M  
INDEX

## Axial Grooving O-Rings for Twin Cutter Tools Insert Form 304

Carbide

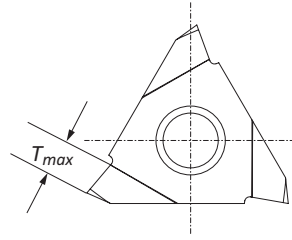

									Carbide											
									Uncoated				Coated							
									WHW01	WHW16	WHW20	WHC05	WHC18	WHC19	WHC79	WHC98	WHC111	WHC114	WHC136	WHC164
Geometry	Boring Range	O-Ring Cross Section	B + 0.05	B <sub>max</sub>	T <sub>max</sub>	R ± 0.05	Part No.													
<b>Steel</b>	P																			▼▼
<b>Stainless Steel</b>	M																			▽▽
<b>Cast Iron Nonferrous Materials</b>	K																			▼▼
<b>Nonferrous Materials</b>	N																			
<b>Titanium</b>	S																			▼▼
<b>Hard Materials</b>	H																			
<b>i</b>		2.086 - 39.37	0.039 - 0.059	0.059	0.098	0.064	0.008	297976												●
		2.086 - 39.37	0.039 - 0.059	0.086	0.145	0.092	0.012	297977												●
		2.086 - 39.37	0.039 - 0.059	0.133	0.224	0.143	0.020	297978												●
		2.086 - 39.37	0.039 - 0.059	0.212	0.358	0.194	0.031	297979												●
<b>m</b>		53.00 - 1000.00	1.00 - 1.50	1.50	2.50	1.65	0.20	297976												●
		53.00 - 1000.00	1.50 - 2.40	2.20	3.70	2.35	0.30	297977												●
		53.00 - 1000.00	2.40 - 4.00	3.40	5.70	3.65	0.50	297978												●
		53.00 - 1000.00	4.00 - 5.50	5.40	9.10	4.95	0.80	297979												●

### Reference Key

Symbol	Machining Conditions
●	Average - Main Application

### Reference Key



Symbol	Insert Type
▼▼	Universal - Main Application
▽▽	Universal - Extended Application

Insert Form	Countersunk Screw		Torque Driver	Service Key	Technical Data	
	Part No.	Size	Part No.	Part No.	Torque	Key Size
304	215392	M5 x 0.8 x 12.9	415543	215150	5.0 Nm	T20

# Insert Form 325

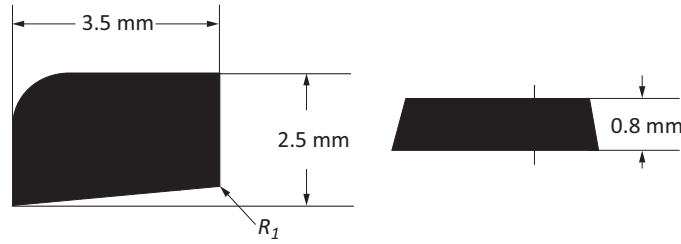
Carbide



				Carbide											
				Uncoated				Coated							
Material	Code			WHW01	WHW16	WHW20	WHC05	WHC18	WHC19	WHC79	WHC98	WHC111	WHC114	WHC136	WHC164
Steel	P													▼▼	
Stainless Steel	M													▼▼	
Cast Iron Nonferrous Materials	K					▼▼								▼▼	
Nonferrous Materials	N					▼▼									
Titanium	S													▼▼	
Hard Materials	H														
Geometry	Radius $R_1$	Description	Part No.	WHW01	WHW16	WHW20	WHC05	WHC18	WHC19	WHC79	WHC98	WHC111	WHC114	WHC136	WHC164
 860	0.004	F32501CN860	097831			●								●	
 860	0.10	F32501CN860	097831			●								●	

Insert Form	Countersunk Screw	Clamping Jaw	Torque Driver	Service Key	Technical Data	
					Torque	Key Size
325	315321 M1.6 x 0.35 x 3	315320	-	315322	0.3 Nm	0.5x3

Reference Key

Symbol	Machining Conditions
●	Average - Main Application

Reference Key

Symbol	Insert Type
▼▼	Finishing - Main Application
▼▼	Finishing - Extended Application

A  
B  
C  
D  
E  
F  
G  
H  
I  
J  
K  
L  
M  
INDEX

## Insert Accessories

Countersunk Screws | Torque Drivers

Insert Form	Countersunk Screw		Clamping Jaw	Torque Driver		Service Key		Technical Data	
						Torque	Key Size		
04	<b>415977</b>	M4 x 0.7 x 7.9	–	<b>415510</b>	<b>115664</b>	3.0 Nm	T15		
05	<b>415949</b>	M4 x 0.7 x 11	–	<b>415543</b>	<b>215150</b>	5.0 Nm	T20		
20	<b>115535</b>	M2 x 0.4 x 5	–	<b>415508</b>	<b>115591</b>	0.9 Nm	T7		
39	<b>115673</b>	M3.5 x 0.6 x 9	–	<b>414510</b>	<b>115664</b>	3.0 Nm	T15		
47	<b>315324</b>	M1.8 x 0.35 x 4	<b>315323</b>	–	<b>115537</b>	0.5 Nm	T6		
89	<b>115676</b>	M2.5 x 0.45 x 5	–	<b>415514</b>	<b>115590</b>	1.2 Nm	T8		
90	<b>115531</b>	M3 x 0.5 x 7.5	–	<b>415514</b>	<b>115590</b>	1.2 Nm	T8		
91	<b>115802</b>	M3 x 0.5 x 12	–	<b>415514</b>	<b>115590</b>	1.2 Nm	T8		
101	<b>115676</b>	M2.5 x 0.45 x 5	–	<b>415514</b>	<b>115590</b>	1.2 Nm	T8		
103	<b>115672(&lt;Ø37mm)</b>	M3.5 x 0.6 x 7.5	–	<b>415510</b>	<b>115664</b>	3.0 Nm	T15		
103	<b>115673(&gt;Ø36mm)</b>	M3.5 x 0.6 x 9	–	<b>415510</b>	<b>115664</b>	3.0 Nm	T15		
104	<b>215149</b>	M4.5 x 0.75 x 11.5	–	<b>415543</b>	<b>215150</b>	5.0 Nm	T20		
105	<b>215149</b>	M4.5 x 0.75 x 11.5	–	<b>415543</b>	<b>215150</b>	5.0 Nm	T20		
111	<b>115531</b>	M3 x 0.5 x 7.5	–	<b>415514</b>	<b>115590</b>	1.2 Nm	T8		
112	<b>115672(&lt;Ø37mm)</b>	M3.5 x 0.6 x 7.5	–	<b>415510</b>	<b>115664</b>	3.0 Nm	T15		
112	<b>115673(&gt;Ø36mm)</b>	M3.5 x 0.6 x 9	–	<b>415510</b>	<b>115664</b>	3.0 Nm	T15		
113	<b>215149</b>	M4.5 x 0.75 x 11.5	–	<b>415543</b>	<b>215150</b>	5.0 Nm	T20		
114	<b>215149</b>	M4.5 x 0.75 x 11.5	–	<b>415543</b>	<b>215150</b>	5.0 Nm	T20		
161	<b>115676</b>	M2.5 x 0.45 x 5	–	<b>415514</b>	<b>115590</b>	1.2 Nm	T8		
163	<b>115673</b>	M3.5 x 0.6 x 9	–	<b>415510</b>	<b>115664</b>	3.0 Nm	T15		
211	<b>215377</b>	M2 x 0.4 x 4	–	<b>415507</b>	<b>115537</b>	0.6 Nm	T6		
262	<b>215987</b>	M2.5 x 0.45 x 6	–	<b>415514</b>	<b>115590</b>	1.2 Nm	T8		
264	<b>115673</b>	M3.5 x 0.6 x 9	–	<b>415510</b>	<b>115664</b>	3.0 Nm	T15		
304	<b>215392</b>	M5 x 0.8 x 12.9	–	<b>415543</b>	<b>215150</b>	5.0 Nm	T20		
325	<b>315321</b>	M1.6 x 0.35 x 3	<b>315320</b>	–	<b>315322</b>	0.3 Nm	0.5x3		
394	<b>215915</b>	M2.5 x 0.45 x 7	–	<b>415514</b>	<b>115590</b>	1.1 Nm	T8		
395	<b>215985</b>	M3 x 0.5 x 7.5	–	<b>415514</b>	<b>115590</b>	1.2 Nm	T8		
396	<b>415320</b>	M3.5 x 0.6 x 11	–	<b>415510</b>	<b>115664</b>	3.0 Nm	T15		
397	<b>215149</b>	M4.5 x 0.75 x 11.5	–	<b>415543</b>	<b>215150</b>	5.0 Nm	T20		

## Insert Accessories

Countersunk Screws | Torque Drivers

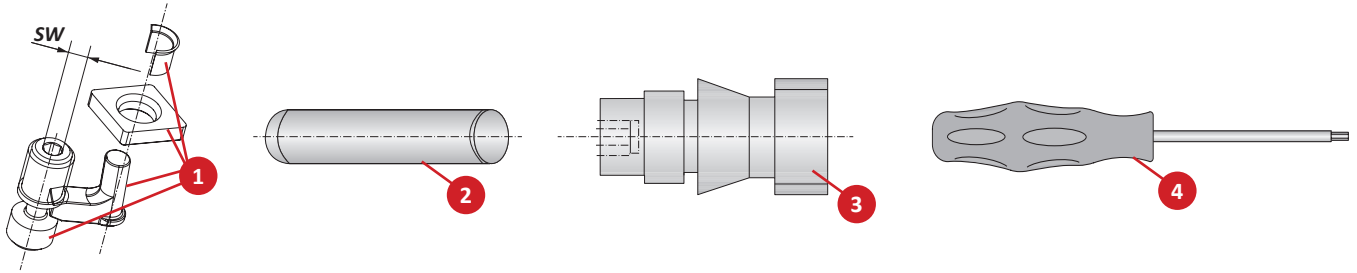

Insert Form	1. Clamping Set		2. Mounting Arbor for Sleeve		3. Clamping Bolt		4. Service Key	
	Part No.	Key Size	Part No.	Part No.	Key Size	Part No.	Key Size	
75	315004	s3	415642	-	-	415578	s3	
123	315003	s3	415642	115775	s2.5	415578 115575	s3 s2.5	
124	315054	s3	415644	115776	s3	415578 115630	s3 s3	

A  
B  
C  
D  
E  
F  
G  
H  
I  
J  
K  
L  
M  
INDEX

## Technical Information

### Surface Finish | General Formulas

The corner radius of replaceable inserts is very important in finish machining. Large corner radii (0.031" (0.8 mm) or higher allow for high feed rates with good surface quality.

The expected surface quality can be estimated by using the function of corner radius and feed rate formula.

	<p>1. The larger the corner radius and the lighter the feed rate is, the better the surface quality.</p>
	<p>2. If the feed is approximately 1/3 of the corner radius, the better the machining time and surface finish will be in finish machining applications.</p>
	<p>3. A larger corner radius increases radial forces, which can negatively affect dimensional accuracy. Large corner radii also require increased depth of cut.</p>



Minimum depth of cut ( $a_p$ ) should at least match the corner radius. This minimizes the radial forces.

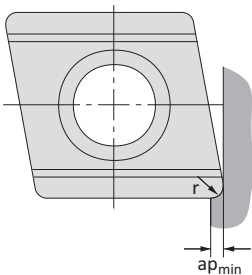

General Formulas		
Cutting Speed	$\frac{V_c = D \times \pi \times n}{1000}$	(m/min)
RPM	$\frac{n = V_c \times 1000}{D \times \pi}$	(min <sup>-1</sup> )
Feed Speed	$V_f = f \times n$	(mm/min)
	$D = \text{Machining } \varnothing$	(mm)
	$f = \text{Feed}$	(mm/u)
	$V_c = \text{Cutting Speed}$	(m/min)
	$n = \text{RPM}$	(min <sup>-1</sup> )

## Technical Information

### Wiper Geometries

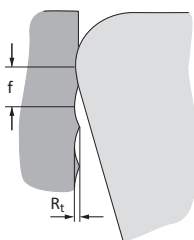
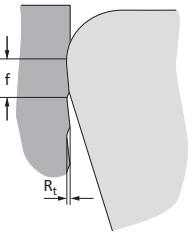
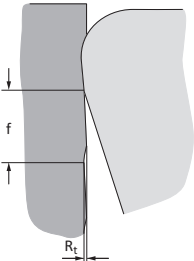
Replaceable Inserts with Wiper Geometry	
Insert with conventional corner radius with feed (f)	
Insert with wiper geometry radius with same feed (f)	
Insert with wiper geometry with increased feed (f)	

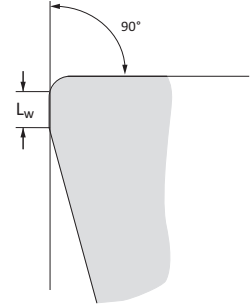
Wiper Geometry for 90° Approach Angle	
<p>Replaceable inserts produce a right-angled step at the bottom of the hole. When used in a Wohlhaupter standard insert holder that has a 90° approach angle, the secondary wiper cutting edge is nearly parallel with the wall of the hole.</p> <p>Wiper geometry for 90° approach angle L<sub>w</sub> = length of the wiper secondary cutting edge</p>	

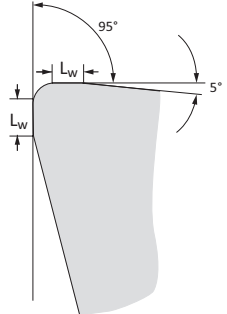
Wiper Geometry for 95° Approach Angle	
<p>Wiper inserts can also be used with 95° insert holders, which are included in the Wohlhaupter standard insert range.</p> <p>Wiper geometry for 95° approach angle (left and right cutting) L<sub>w</sub> = length of the secondary wiper cutting edge</p>	

A  
B  
C  
D  
E  
F  
G  
H  
I  
J  
K  
L  
M  
INDEX

## Rough Machining Recommended Cutting Data | Imperial (inch)

ISO	Material	(BHN) Hardness	Grade	*Speed SFM	Recommended Feed (inch / tooth)			
					Nose Radii			
					0.008"	0.016"	0.032"	0.047"
P	Free-Machining Steel 1118, 1215, 12L14, etc.	100 - 250	Carbide	490 - 750	0.004 - 0.006	0.004 - 0.012	0.008 - 0.020	0.004 - 0.031
			Cermet	490 - 820	0.004 - 0.006	0.004 - 0.012	0.008 - 0.020	0.004 - 0.031
	Low-Carbon Steel 1010, 1020, 1025, 1522, 1144, etc.	85 - 275	Carbide	460 - 820	0.004 - 0.006	0.004 - 0.012	0.008 - 0.020	0.004 - 0.031
	Medium-Carbon Steel 1030, 1040, 1050, 1527, 1140, 1151, etc.	125 - 325	Carbide	460 - 820	0.004 - 0.006	0.004 - 0.012	0.008 - 0.020	0.004 - 0.031
	Alloy Steel 4140, 5140, 8640, etc.	125 - 375	Carbide	390 - 660	0.004 - 0.006	0.004 - 0.012	0.008 - 0.020	0.004 - 0.031
	High-Strength Alloy 4340, 4330V, 300M, etc.	225 - 400	Carbide	330 - 590	0.004 - 0.006	0.004 - 0.012	0.008 - 0.020	0.004 - 0.031
Structural Steel A36, A285, A516, etc.	100 - 350	Carbide	490 - 850	0.004 - 0.006	0.004 - 0.012	0.008 - 0.020	0.004 - 0.031	
		Cermet	490 - 920	0.004 - 0.006	0.004 - 0.012	0.008 - 0.020	0.004 - 0.031	
Tool Steel H-13, H-21, A-4, O-2, S-3, etc.	150 - 250	Carbide	330 - 590	0.004 - 0.006	0.004 - 0.012	0.008 - 0.020	0.004 - 0.031	
S	High-Temp Alloy Hastelloy B, Inconel 600, etc.	140 - 310	Carbide	70 - 160	0.004 - 0.006	0.004 - 0.008	0.006 - 0.014	0.008 - 0.016
	Titanium Alloy	140 - 310	Carbide	130 - 260	0.004 - 0.006	0.004 - 0.008	0.006 - 0.014	0.008 - 0.016
Aerospace Alloy S82	185 - 350	Carbide	130 - 260	0.004 - 0.006	0.004 - 0.008	0.006 - 0.014	0.008 - 0.016	
M	Stainless Steel 400 Series 416, 420, etc.	185 - 350	Carbide	160 - 330	0.004 - 0.006	0.004 - 0.010	0.004 - 0.014	0.008 - 0.024
	Stainless Steel 300 Series 304, 316, 17-4PH, etc.	135 - 275	Carbide	260 - 490	0.004 - 0.006	0.004 - 0.010	0.004 - 0.014	0.008 - 0.024
Super Duplex Stainless Steel	135 - 275	Carbide	200 - 330	0.004 - 0.006	0.004 - 0.010	0.004 - 0.014	0.008 - 0.024	

\*Not to exceed max recommended RPM for boring head found in corresponding Wohlhaupter Operation Manual

### Deep Hole Boring Speed Adjustment

### Recommended Speed Example

⚠ For Dynamic Boring Tool NOVI <sup>TECH</sup> Length			
Boring Type	8xD	9xD	10xD
Roughing	0.80	0.60	0.40
Finishing	0.90	0.70	0.50

If the recommended speed for a finish boring assembly under 5xD is 120 M/Min, then the speed for a 10xD finish boring assembly in the same application would be 60 M/Min (120 M/Min x 0.50 = 60 M/Min)

5xD = 120 M/Min

10xD = 60 M/Min

\*Not to exceed recommended RPM printed on NOVI<sup>TECH</sup> module. Single-edge use is recommended.

**IMPORTANT:** Max spindle speed refers to maximum possible speed for individual boring head and is not a recommended parameter. Factory technical assistance is available for your specific applications through our Application Engineering department. ext: 7611 | email: [appeng@alliedmachine.com](mailto:appeng@alliedmachine.com)

**⚠ WARNING** Tool failure can cause serious injury. To prevent:

- Do not exceed recommended 10xD length-to-diameter ratio or exceed four total components (including shank)
- When using Alu-Line components, do not exceed recommended 5xD length-to-diameter ratio
- When using tool steel components, do not exceed recommended 6xD length-to-diameter ratio
- When using heavy metal components, do not exceed recommended 8xD length-to-diameter ratio
- When using a carbide shank, do not exceed recommended 9xD length-to-diameter ratio
- When using a NOVI<sup>TECH</sup> module, do not exceed recommended 10xD length-to-diameter ratio

Factory technical assistance is available for your specific applications through our Application Engineering department. ext: 7611 | email: [appeng@alliedmachine.com](mailto:appeng@alliedmachine.com)



## Rough Machining Recommended Cutting Data | Imperial (inch)

ISO	Material	(BHN) Hardness	Grade	*Speed SFM	Recommended Feed (inch / tooth) Nose Radii			
					0.008"	0.016"	0.032"	0.047"
H	Wear Plate Hardox®, AR400, T-1, etc.	400 - 600	Carbide	100 - 160	0.002 - 0.006	0.004 - 0.008	0.004 - 0.008	0.004 - 0.010
			CBN	200 - 460	0.002 - 0.006	0.004 - 0.008	0.004 - 0.008	0.004 - 0.010
	Hardened Steel	300 - 500	Carbide	130 - 200	0.002 - 0.006	0.004 - 0.008	0.004 - 0.008	0.004 - 0.010
			CBN	200 - 460	0.002 - 0.006	0.004 - 0.008	0.004 - 0.008	0.004 - 0.010
K	SG / Nodular Cast Iron	120 - 320	Carbide	430 - 820	0.004 - 0.006	0.006 - 0.014	0.008 - 0.020	0.008 - 0.031
			Ceramic	660 - 1310	0.004 - 0.006	0.006 - 0.014	0.008 - 0.020	0.008 - 0.031
	Grey / White Iron	180 - 320	Carbide	490 - 920	0.004 - 0.006	0.006 - 0.014	0.008 - 0.020	0.008 - 0.031
			Ceramic	1310 - 3280	0.004 - 0.006	0.006 - 0.014	0.008 - 0.020	0.008 - 0.031
N	Cast Aluminum	30 - 180	Carbide	820 - 2620	0.004 - 0.006	0.006 - 0.014	0.008 - 0.024	0.008 - 0.031
			PCD	1310 - 3940	0.004 - 0.006	0.006 - 0.014	0.008 - 0.024	0.008 - 0.031
	Wrought Aluminum	30 - 180	Carbide	660 - 1640	0.004 - 0.006	0.006 - 0.014	0.006 - 0.020	0.008 - 0.031
	Aluminum Bronze	100 - 250	Carbide	390 - 820	0.004 - 0.006	0.006 - 0.010	0.006 - 0.016	0.008 - 0.024
	Brass	100	Carbide	660 - 1640	0.004 - 0.006	0.006 - 0.010	0.006 - 0.016	0.008 - 0.031
Copper	60	Carbide	330 - 490	0.004 - 0.006	0.006 - 0.010	0.006 - 0.014	0.008 - 0.016	

\*Not to exceed max recommended RPM for boring head found in corresponding Wohlhaupter Operation Manual

### Deep Hole Boring Speed Adjustment

#### ⚠ For Dynamic Boring Tool NOVI<sup>TECH</sup> Length

Boring Type	8xD	9xD	10xD
Roughing	0.80	0.60	0.40
Finishing	0.90	0.70	0.50

\*Not to exceed recommended RPM printed on NOVI<sup>TECH</sup> module. Single-edge use is recommended.

### Recommended Speed Example

If the recommended speed for a finish boring assembly under 5xD is 120 M/Min, then the speed for a 10xD finish boring assembly in the same application would be 60 M/Min (120 M/Min x 0.50 = 60 M/Min)

5xD = 120 M/Min

10xD = 60 M/Min

**IMPORTANT:** Max spindle speed refers to maximum possible speed for individual boring head and is not a recommended parameter. Factory technical assistance is available for your specific applications through our Application Engineering department. ext: 7611 | email: [appeng@alliedmachine.com](mailto:appeng@alliedmachine.com)

#### ⚠ WARNING Tool failure can cause serious injury. To prevent:

- Do not exceed recommended 10xD length-to-diameter ratio or exceed four total components (including shank)
- When using Alu-Line components, do not exceed recommended 5xD length-to-diameter ratio
- When using tool steel components, do not exceed recommended 6xD length-to-diameter ratio
- When using heavy metal components, do not exceed recommended 8xD length-to-diameter ratio
- When using a carbide shank, do not exceed recommended 9xD length-to-diameter ratio
- When using a NOVI<sup>TECH</sup> module, do not exceed recommended 10xD length-to-diameter ratio

Factory technical assistance is available for your specific applications through our Application Engineering department. ext: 7611 | email: [appeng@alliedmachine.com](mailto:appeng@alliedmachine.com)

## Finish Machining Recommended Cutting Data | Imperial (inch)

ISO	Material	(BHN) Hardness	Grade	*Speed SFM	Recommended Feed (inch / tooth) Nose Radii			
					0.004"	0.008"	0.016"	0.031"
P	Free-Machining Steel 1118, 1215, 12L14, etc.	100 - 250	Carbide	525 - 975	0.001 - 0.003	0.002 - 0.005	0.004 - 0.006	0.006 - 0.009
	Low-Carbon Steel 1010, 1020, 1025, 1522, 1144, etc.	85 - 275	Carbide	475 - 925	0.001 - 0.002	0.002 - 0.004	0.003 - 0.005	0.005 - 0.008
	Medium-Carbon Steel 1030, 1040, 1050, 1527, 1140, 1151, etc.	125 - 325	Carbide	475 - 825	0.001 - 0.002	0.002 - 0.004	0.003 - 0.005	0.005 - 0.008
	Alloy Steel 4140, 5140, 8640, etc.	125 - 375	Carbide	400 - 700	0.001 - 0.002	0.002 - 0.004	0.003 - 0.005	0.005 - 0.008
	High-Strength Alloy 4340, 4330V, 300M, etc.	225 - 400	Carbide	325 - 600	0.001 - 0.002	0.002 - 0.004	0.003 - 0.005	0.005 - 0.008
	Structural Steel A36, A285, A516, etc.	100 - 350	Carbide	475 - 925	0.001 - 0.002	0.002 - 0.004	0.003 - 0.005	0.005 - 0.008
	Tool Steel H-13, H-21, A-4, O-2, S-3, etc.	150 - 250	Carbide	325 - 600	0.001 - 0.002	0.002 - 0.003	0.003 - 0.004	0.004 - 0.006
S	High-Temp Alloy Hastelloy B, Inconel 600, etc.	140 - 310	Carbide	100 - 225	0.001 - 0.002	0.002 - 0.003	0.003 - 0.005	0.004 - 0.006
	Titanium Alloy	140 - 310	Carbide	125 - 300	0.001 - 0.002	0.002 - 0.003	0.003 - 0.005	0.004 - 0.006
	Aerospace Alloy S82	185 - 350	Carbide	125 - 300	0.001 - 0.002	0.002 - 0.003	0.003 - 0.005	0.004 - 0.006
M	Stainless Steel 400 Series 416, 420, etc.	185 - 350	Carbide	164 - 394	0.001 - 0.002	0.002 - 0.004	0.003 - 0.004	0.004 - 0.006
	Stainless Steel 300 Series 304, 316, 17-4PH, etc.	135 - 275	Carbide	300 - 525	0.001 - 0.002	0.002 - 0.004	0.003 - 0.004	0.004 - 0.006
	Super Duplex Stainless Steel	135 - 275	Carbide	197 - 525	0.001 - 0.002	0.002 - 0.004	0.003 - 0.004	0.004 - 0.006

\*Not to exceed max recommended RPM for boring head found in corresponding Wohlhaupter Operation Manual

### Deep Hole Boring Speed Adjustment

### Recommended Speed Example

⚠ For Dynamic Boring Tool NOVI <sup>TECH</sup> Length			
Boring Type	8xD	9xD	10xD
Roughing	0.80	0.60	0.40
Finishing	0.90	0.70	0.50

If the recommended speed for a finish boring assembly under 5xD is 120 M/Min, then the speed for a 10xD finish boring assembly in the same application would be 60 M/Min (120 M/Min x 0.50 = 60 M/Min)

5xD = 120 M/Min

10xD = 60 M/Min

\*Not to exceed recommended RPM printed on NOVI<sup>TECH</sup> module

**IMPORTANT:** Max spindle speed refers to maximum possible speed for individual boring head and is not a recommended parameter. Factory technical assistance is available for your specific applications through our Application Engineering department. ext: 7611 | email: [appeng@alliedmachine.com](mailto:appeng@alliedmachine.com)

**⚠ WARNING** Tool failure can cause serious injury. To prevent:

- Do not exceed recommended 10xD length-to-diameter ratio or exceed four total components (including shank)
- When using Alu-Line components, do not exceed recommended 5xD length-to-diameter ratio
- When using tool steel components, do not exceed recommended 6xD length-to-diameter ratio
- When using heavy metal components, do not exceed recommended 8xD length-to-diameter ratio
- When using a carbide shank, do not exceed recommended 9xD length-to-diameter ratio
- When using a NOVI<sup>TECH</sup> module, do not exceed recommended 10xD length-to-diameter ratio

Factory technical assistance is available for your specific applications through our Application Engineering department. ext: 7611 | email: [appeng@alliedmachine.com](mailto:appeng@alliedmachine.com)

## Finish Machining Recommended Cutting Data | Imperial (inch)

ISO	Material	(BHN) Hardness	Grade	*Speed SFM	Recommended Feed (inch / tooth) Nose Radii			
					0.004"	0.008"	0.016"	0.031"
H	Wear Plate Hardox®, AR400, T-1, etc.	400 - 600	Carbide	100 - 200	0.001 - 0.002	0.002 - 0.003	0.003 - 0.004	0.004 - 0.006
			CBN	225 - 600	0.001 - 0.002	0.002 - 0.003	0.003 - 0.004	0.004 - 0.006
	Hardened Steel	300 - 500	Carbide	125 - 275	0.001 - 0.002	0.002 - 0.003	0.003 - 0.004	0.004 - 0.006
			CBN	225 - 600	0.001 - 0.002	0.002 - 0.003	0.003 - 0.004	0.004 - 0.006
K	SG / Nodular Cast Iron	120 - 320	Carbide	475 - 850	0.001 - 0.002	0.002 - 0.004	0.003 - 0.005	0.005 - 0.008
	Grey / White Iron	180 - 320	Carbide	600 - 1050	0.001 - 0.002	0.002 - 0.004	0.003 - 0.005	0.005 - 0.008
			CBN	1325 - 3275	0.001 - 0.002	0.002 - 0.004	0.003 - 0.005	0.005 - 0.008
N	Cast Aluminum	30 - 180	Carbide	850 - 2800	0.001 - 0.002	0.002 - 0.004	0.003 - 0.005	0.005 - 0.008
			PCD	1625 - 6550	0.001 - 0.002	0.002 - 0.004	0.003 - 0.005	0.005 - 0.008
	Wrought Aluminum	30 - 180	Carbide	675 - 1975	0.001 - 0.003	0.002 - 0.005	0.004 - 0.006	0.006 - 0.009
	Aluminum Bronze	100 - 250	Carbide	475 - 925	0.001 - 0.002	0.002 - 0.004	0.004 - 0.005	0.005 - 0.008
	Brass	100	Carbide	675 - 1975	0.001 - 0.002	0.002 - 0.004	0.003 - 0.005	0.005 - 0.008
Copper	60	Carbide	325 - 600	0.001 - 0.002	0.002 - 0.003	0.003 - 0.004	0.004 - 0.005	

\*Not to exceed max recommended RPM for boring head found in corresponding Wohlhaupter Operation Manual

### Deep Hole Boring Speed Adjustment

⚠ For Dynamic Boring Tool NOVI <sup>TECH</sup> Length			
Boring Type	8xD	9xD	10xD
Roughing	0.80	0.60	0.40
Finishing	0.90	0.70	0.50

\*Not to exceed recommended RPM printed on NOVI<sup>TECH</sup> module

### Recommended Speed Example

If the recommended speed for a finish boring assembly under 5xD is 120 M/Min, then the speed for a 10xD finish boring assembly in the same application would be 60 M/Min (120 M/Min x 0.50 = 60 M/Min)

5xD = 120 M/Min

10xD = 60 M/Min

**IMPORTANT:** Max spindle speed refers to maximum possible speed for individual boring head and is not a recommended parameter. Factory technical assistance is available for your specific applications through our Application Engineering department. ext: 7611 | email: [appeng@alliedmachine.com](mailto:appeng@alliedmachine.com)

#### ⚠ WARNING Tool failure can cause serious injury. To prevent:

- Do not exceed recommended 10xD length-to-diameter ratio or exceed four total components (including shank)
- When using Alu-Line components, do not exceed recommended 5xD length-to-diameter ratio
- When using tool steel components, do not exceed recommended 6xD length-to-diameter ratio
- When using heavy metal components, do not exceed recommended 8xD length-to-diameter ratio
- When using a carbide shank, do not exceed recommended 9xD length-to-diameter ratio
- When using a NOVI<sup>TECH</sup> module, do not exceed recommended 10xD length-to-diameter ratio

Factory technical assistance is available for your specific applications through our Application Engineering department. ext: 7611 | email: [appeng@alliedmachine.com](mailto:appeng@alliedmachine.com)

## Rough Machining Recommended Cutting Data | Metric (mm)

ISO	Material	(BHN) Hardness	Grade	*Speed M / Min	Recommended Feed (mm / tooth) Nose Radii			
					0.2 mm	0.4 mm	0.8 mm	1.2 mm
P	Free-Machining Steel 1118, 1215, 12L14, etc.	100 - 250	Carbide	150 - 230	0.10 - 0.15	0.10 - 0.30	0.20 - 0.50	0.10 - 0.80
	Cermet		150 - 250	0.10 - 0.15	0.10 - 0.30	0.20 - 0.50	0.10 - 0.80	
	Low-Carbon Steel 1010, 1020, 1025, 1522, 1144, etc.	85 - 275	Carbide	140 - 250	0.10 - 0.15	0.10 - 0.30	0.20 - 0.50	0.10 - 0.80
	Medium-Carbon Steel 1030, 1040, 1050, 1527, 1140, 1151, etc.		Carbide	140 - 250	0.10 - 0.15	0.10 - 0.30	0.20 - 0.50	0.10 - 0.80
	Alloy Steel 4140, 5140, 8640, etc.	125 - 375	Carbide	120 - 200	0.10 - 0.15	0.10 - 0.30	0.20 - 0.50	0.10 - 0.80
	High-Strength Alloy 4340, 4330V, 300M, etc.		Carbide	100 - 180	0.10 - 0.15	0.10 - 0.30	0.20 - 0.50	0.10 - 0.80
	Structural Steel A36, A285, A516, etc.	100 - 350	Carbide	150 - 260	0.10 - 0.15	0.10 - 0.30	0.20 - 0.50	0.10 - 0.80
	Cermet		150 - 280	0.10 - 0.15	0.10 - 0.30	0.20 - 0.50	0.10 - 0.80	
	Tool Steel H-13, H-21, A-4, O-2, S-3, etc.	150 - 250	Carbide	100 - 180	0.10 - 0.15	0.10 - 0.30	0.20 - 0.50	0.10 - 0.80
	High-Temp Alloy Hastelloy B, Inconel 600, etc.		Carbide	20 - 50	0.10 - 0.15	0.10 - 0.2	0.15 - 0.35	0.20 - 0.40
S	Titanium Alloy	140 - 310	Carbide	40 - 80	0.10 - 0.15	0.10 - 0.2	0.15 - 0.35	0.20 - 0.40
	Aerospace Alloy S82		Carbide	40 - 80	0.10 - 0.15	0.10 - 0.2	0.15 - 0.35	0.20 - 0.40
	Stainless Steel 400 Series 416, 420, etc.	185 - 350	Carbide	50 - 100	0.10 - 0.15	0.10 - 0.25	0.10 - 0.35	0.20 - 0.60
Stainless Steel 300 Series 304, 316, 17-4PH, etc.	Carbide		80 - 150	0.10 - 0.15	0.10 - 0.25	0.10 - 0.35	0.20 - 0.60	
Super Duplex Stainless Steel	Carbide		60 - 100	0.10 - 0.15	0.10 - 0.25	0.10 - 0.35	0.20 - 0.60	

\*Not to exceed max recommended RPM for boring head found in corresponding Wohlhaupter Operation Manual

### Deep Hole Boring Speed Adjustment

### Recommended Speed Example

⚠ For Dynamic Boring Tool NOVI <sup>TECH</sup> Length			
Boring Type	8xD	9xD	10xD
Roughing	0.80	0.60	0.40
Finishing	0.90	0.70	0.50

If the recommended speed for a finish boring assembly under 5xD is 120 M/Min, then the speed for a 10xD finish boring assembly in the same application would be 60 M/Min (120 M/Min x 0.50 = 60 M/Min)	
5xD = 120 M/Min	10xD = 60 M/Min

\*Not to exceed recommended RPM printed on NOVI<sup>TECH</sup> module. Single-edge use is recommended.

**IMPORTANT:** Max spindle speed refers to maximum possible speed for individual boring head and is not a recommended parameter. Factory technical assistance is available for your specific applications through our Application Engineering department. ext: 7611 | email: [appeng@alliedmachine.com](mailto:appeng@alliedmachine.com)

**⚠ WARNING** Tool failure can cause serious injury. To prevent:

- Do not exceed recommended 10xD length-to-diameter ratio or exceed four total components (including shank)
- When using Alu-Line components, do not exceed recommended 5xD length-to-diameter ratio
- When using tool steel components, do not exceed recommended 6xD length-to-diameter ratio
- When using heavy metal components, do not exceed recommended 8xD length-to-diameter ratio
- When using a carbide shank, do not exceed recommended 9xD length-to-diameter ratio
- When using a NOVI<sup>TECH</sup> module, do not exceed recommended 10xD length-to-diameter ratio

Factory technical assistance is available for your specific applications through our Application Engineering department. ext: 7611 | email: [appeng@alliedmachine.com](mailto:appeng@alliedmachine.com)

A  
B  
C  
D  
E  
F  
G  
H  
I  
J  
K  
L  
M  
INDEX

## Rough Machining Recommended Cutting Data | Metric (mm)

ISO	Material	(BHN) Hardness	Grade	*Speed M / Min	Recommended Feed (mm / tooth) Nose Radii			
					0.2 mm	0.4 mm	0.8 mm	1.2 mm
H	Wear Plate Hardox®, AR400, T-1, etc.	400 - 600	Carbide	30 - 50	0.05 - 0.15	0.10 - 0.20	0.10 - 0.20	0.10 - 0.25
			CBN	60 - 140	0.05 - 0.15	0.10 - 0.20	0.10 - 0.20	0.10 - 0.25
	Hardened Steel	300 - 500	Carbide	40 - 60	0.05 - 0.15	0.10 - 0.20	0.10 - 0.20	0.10 - 0.25
			CBN	60 - 140	0.05 - 0.15	0.10 - 0.20	0.10 - 0.20	0.10 - 0.25
K	SG / Nodular Cast Iron	120 - 320	Carbide	130 - 250	0.10 - 0.15	0.15 - 0.35	0.20 - 0.50	0.20 - 0.80
			Ceramic	200 - 400	0.10 - 0.15	0.15 - 0.35	0.20 - 0.50	0.20 - 0.80
	Grey / White Iron	180 - 320	Carbide	150 - 280	0.10 - 0.15	0.15 - 0.35	0.20 - 0.60	0.20 - 0.80
			Ceramic	400 - 1000	0.10 - 0.15	0.15 - 0.35	0.20 - 0.60	0.20 - 0.80
N	Cast Aluminum	30 - 180	Carbide	250 - 800	0.10 - 0.15	0.15 - 0.35	0.20 - 0.60	0.20 - 0.80
			PCD	400 - 1200	0.10 - 0.15	0.15 - 0.35	0.20 - 0.60	0.20 - 0.80
	Wrought Aluminum	30 - 180	Carbide	200 - 500	0.10 - 0.15	0.15 - 0.35	0.15 - 0.50	0.20 - 0.80
	Aluminum Bronze	100 - 250	Carbide	120 - 250	0.10 - 0.15	0.15 - 0.25	0.15 - 0.40	0.20 - 0.60
	Brass	100	Carbide	200 - 500	0.10 - 0.15	0.15 - 0.25	0.15 - 0.40	0.20 - 0.80
Copper	60	Carbide	100 - 150	0.10 - 0.15	0.15 - 0.25	0.15 - 0.35	0.20 - 0.40	

\*Not to exceed max recommended RPM for boring head found in corresponding Wohlhaupter Operation Manual

### Deep Hole Boring Speed Adjustment

#### ⚠ For Dynamic Boring Tool NOVI<sup>TECH</sup> Length

Boring Type	8xD	9xD	10xD
Roughing	0.80	0.60	0.40
Finishing	0.90	0.70	0.50

\*Not to exceed recommended RPM printed on NOVI<sup>TECH</sup> module. Single-edge use is recommended.

### Recommended Speed Example

If the recommended speed for a finish boring assembly under 5xD is 120 M/Min, then the speed for a 10xD finish boring assembly in the same application would be 60 M/Min (120 M/Min x 0.50 = 60 M/Min)

5xD = 120 M/Min

10xD = 60 M/Min

**IMPORTANT:** Max spindle speed refers to maximum possible speed for individual boring head and is not a recommended parameter. Factory technical assistance is available for your specific applications through our Application Engineering department. ext: 7611 | email: [appeng@alliedmachine.com](mailto:appeng@alliedmachine.com)

#### ⚠ WARNING Tool failure can cause serious injury. To prevent:

- Do not exceed recommended 10xD length-to-diameter ratio or exceed four total components (including shank)
- When using Alu-Line components, do not exceed recommended 5xD length-to-diameter ratio
- When using tool steel components, do not exceed recommended 6xD length-to-diameter ratio
- When using heavy metal components, do not exceed recommended 8xD length-to-diameter ratio
- When using a carbide shank, do not exceed recommended 9xD length-to-diameter ratio
- When using a NOVI<sup>TECH</sup> module, do not exceed recommended 10xD length-to-diameter ratio

Factory technical assistance is available for your specific applications through our Application Engineering department. ext: 7611 | email: [appeng@alliedmachine.com](mailto:appeng@alliedmachine.com)

A  
B  
C  
D  
E  
F  
G  
H  
I  
J  
K  
L  
M  
INDEX

## Finish Machining Recommended Cutting Data | Metric (mm)

ISO	Material	(BHN) Hardness	Grade	*Speed M / Min	Recommended Feed (mm / tooth) Nose Radii			
					0.1 mm	0.2 mm	0.4 mm	0.8 mm
P	Free-Machining Steel 1118, 1215, 12L14, etc.	100 - 250	Carbide	150 - 300	0.02 - 0.08	0.05 - 0.13	0.10 - 0.15	0.15 - 0.23
	Low-Carbon Steel 1010, 1020, 1025, 1522, 1144, etc.	85 - 275	Carbide	145 - 280	0.02 - 0.05	0.05 - 0.10	0.08 - 0.13	0.13 - 0.20
	Medium-Carbon Steel 1030, 1040, 1050, 1527, 1140, 1151, etc.	125 - 325	Carbide	145 - 280	0.02 - 0.05	0.05 - 0.10	0.08 - 0.13	0.13 - 0.20
	Alloy Steel 4140, 5140, 8640, etc.	125 - 375	Carbide	120 - 215	0.02 - 0.05	0.05 - 0.10	0.08 - 0.13	0.13 - 0.20
	High-Strength Alloy 4340, 4330V, 300M, etc.	225 - 400	Carbide	100 - 180	0.02 - 0.05	0.05 - 0.10	0.08 - 0.13	0.13 - 0.20
	Structural Steel A36, A285, A516, etc.	100 - 350	Carbide	145 - 280	0.02 - 0.05	0.05 - 0.10	0.08 - 0.13	0.13 - 0.20
	Tool Steel H-13, H-21, A-4, O-2, S-3, etc.	150 - 250	Carbide	100 - 180	0.02 - 0.05	0.05 - 0.08	0.08 - 0.10	0.10 - 0.15
S	High-Temp Alloy Hastelloy B, Inconel 600, etc.	140 - 310	Carbide	30 - 70	0.02 - 0.05	0.05 - 0.08	0.08 - 0.13	0.10 - 0.15
	Titanium Alloy	140 - 310	Carbide	40 - 90	0.02 - 0.05	0.05 - 0.08	0.08 - 0.13	0.10 - 0.15
	Aerospace Alloy S82	185 - 350	Carbide	40 - 90	0.02 - 0.05	0.05 - 0.08	0.08 - 0.13	0.10 - 0.15
M	Stainless Steel 400 Series 416, 420, etc.	185 - 350	Carbide	50 - 120	0.02 - 0.05	0.05 - 0.10	0.08 - 0.10	0.10 - 0.15
	Stainless Steel 300 Series 304, 316, 17-4PH, etc.	135 - 275	Carbide	90 - 160	0.02 - 0.05	0.05 - 0.10	0.08 - 0.10	0.10 - 0.15
	Super Duplex Stainless Steel	135 - 275	Carbide	60 - 160	0.02 - 0.05	0.05 - 0.10	0.08 - 0.10	0.10 - 0.15

\*Not to exceed max recommended RPM for boring head found in corresponding Wohlhaupter Operation Manual

### Deep Hole Boring Speed Adjustment

### Recommended Speed Example

⚠ For Dynamic Boring Tool NOVI <sup>TECH</sup> Length			
Boring Type	8xD	9xD	10xD
Roughing	0.80	0.60	0.40
Finishing	0.90	0.70	0.50

If the recommended speed for a finish boring assembly under 5xD is 120 M/Min, then the speed for a 10xD finish boring assembly in the same application would be 60 M/Min (120 M/Min x 0.50 = 60 M/Min)

5xD = 120 M/Min

10xD = 60 M/Min

\*Not to exceed recommended RPM printed on NOVI<sup>TECH</sup> module

**IMPORTANT:** Max spindle speed refers to maximum possible speed for individual boring head and is not a recommended parameter. Factory technical assistance is available for your specific applications through our Application Engineering department. ext: 7611 | email: [appeng@alliedmachine.com](mailto:appeng@alliedmachine.com)

#### ⚠ WARNING Tool failure can cause serious injury. To prevent:

- Do not exceed recommended 10xD length-to-diameter ratio or exceed four total components (including shank)
- When using Alu-Line components, do not exceed recommended 5xD length-to-diameter ratio
- When using tool steel components, do not exceed recommended 6xD length-to-diameter ratio
- When using heavy metal components, do not exceed recommended 8xD length-to-diameter ratio
- When using a carbide shank, do not exceed recommended 9xD length-to-diameter ratio
- When using a NOVI<sup>TECH</sup> module, do not exceed recommended 10xD length-to-diameter ratio

Factory technical assistance is available for your specific applications through our Application Engineering department. ext: 7611 | email: [appeng@alliedmachine.com](mailto:appeng@alliedmachine.com)

## Finish Machining Recommended Cutting Data | Metric (mm)

ISO	Material	(BHN) Hardness	Grade	*Speed M / Min	Recommended Feed (mm / tooth) Nose Radii			
					0.1 mm	0.2 mm	0.4 mm	0.8 mm
H	Wear Plate Hardox®, AR400, T-1, etc.	400 - 600	Carbide	30 - 60	0.02 - 0.05	0.05 - 0.08	0.08 - 0.10	0.10 - 0.15
			CBN	70 - 180	0.02 - 0.05	0.05 - 0.08	0.08 - 0.10	0.10 - 0.15
	Hardened Steel	300 - 500	Carbide	40 - 80	0.02 - 0.05	0.05 - 0.08	0.08 - 0.10	0.10 - 0.15
			CBN	70 - 180	0.02 - 0.05	0.05 - 0.08	0.08 - 0.10	0.10 - 0.15
K	SG / Nodular Cast Iron	120 - 320	Carbide	145 - 260	0.02 - 0.05	0.05 - 0.10	0.08 - 0.13	0.13 - 0.20
	Grey / White Iron	180 - 320	Carbide	180 - 320	0.02 - 0.05	0.05 - 0.10	0.08 - 0.13	0.13 - 0.20
			CBN	400 - 1000	0.02 - 0.05	0.05 - 0.10	0.08 - 0.13	0.13 - 0.20
N	Cast Aluminum	30 - 180	Carbide	260 - 850	0.02 - 0.05	0.05 - 0.10	0.08 - 0.13	0.13 - 0.20
			PCD	495 - 1995	0.02 - 0.05	0.05 - 0.10	0.08 - 0.13	0.13 - 0.20
	Wrought Aluminum	30 - 180	Carbide	205 - 600	0.02 - 0.05	0.05 - 0.13	0.10 - 0.15	0.15 - 0.23
	Aluminum Bronze	100 - 250	Carbide	145 - 280	0.02 - 0.05	0.05 - 0.10	0.10 - 0.13	0.13 - 0.20
	Brass	100	Carbide	205 - 600	0.02 - 0.05	0.05 - 0.10	0.08 - 0.13	0.13 - 0.20
Copper	60	Carbide	100 - 180	0.02 - 0.05	0.05 - 0.08	0.08 - 0.10	0.10 - 0.13	

\*Not to exceed max recommended RPM for boring head found in corresponding Wohlhaupter Operation Manual

### Deep Hole Boring Speed Adjustment

#### ⚠ For Dynamic Boring Tool NOVI<sup>TECH</sup> Length

Boring Type	8xD	9xD	10xD
Roughing	0.80	0.60	0.40
Finishing	0.90	0.70	0.50

\*Not to exceed recommended RPM printed on NOVI<sup>TECH</sup> module

### Recommended Speed Example

If the recommended speed for a finish boring assembly under 5xD is 120 M/Min, then the speed for a 10xD finish boring assembly in the same application would be 60 M/Min (120 M/Min x 0.50 = 60 M/Min)

5xD = 120 M/Min

10xD = 60 M/Min

**IMPORTANT:** Max spindle speed refers to maximum possible speed for individual boring head and is not a recommended parameter. Factory technical assistance is available for your specific applications through our Application Engineering department. ext: 7611 | email: [appeng@alliedmachine.com](mailto:appeng@alliedmachine.com)

#### ⚠ WARNING Tool failure can cause serious injury. To prevent:

- Do not exceed recommended 10xD length-to-diameter ratio or exceed four total components (including shank)
- When using Alu-Line components, do not exceed recommended 5xD length-to-diameter ratio
- When using tool steel components, do not exceed recommended 6xD length-to-diameter ratio
- When using heavy metal components, do not exceed recommended 8xD length-to-diameter ratio
- When using a carbide shank, do not exceed recommended 9xD length-to-diameter ratio
- When using a NOVI<sup>TECH</sup> module, do not exceed recommended 10xD length-to-diameter ratio

Factory technical assistance is available for your specific applications through our Application Engineering department. ext: 7611 | email: [appeng@alliedmachine.com](mailto:appeng@alliedmachine.com)

## Boring Insert Wear Patterns

### Built-up Edge

#### Potential Problem

- Machined material adheres to the cutting edge of insert
- When it breaks, the edge becomes brittle and cracks
- This can negatively affect machined surface

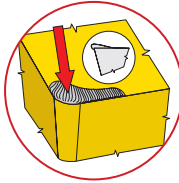

#### Possible Solution

- Increase temperature by increasing speed or feed
- Use an insert with higher lubricity coating
- Choose a freer cutting insert geometry

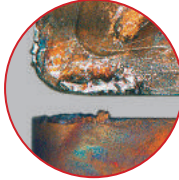

### Comb Cracks

#### Potential Problem

- Caused by high stress on the cutting edge during interrupted cuts

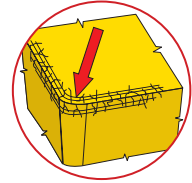

#### Possible Solution

- Switch off coolant or increase coolant flow to obtain an even temperature level
- Reduce cutting speed
- Use tougher insert grade

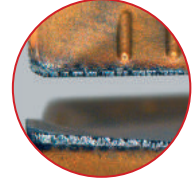

### Flank Wear

#### Potential Problem

- Caused by friction between the insert and machined material
- It cannot be fully eliminated, but it can be reduced

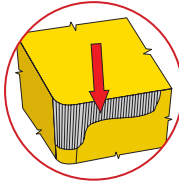

#### Possible Solution

- Use a more wear-resistant grade
- Reduce cutting speed
- Use coolant or increase coolant flow to the cutting edge

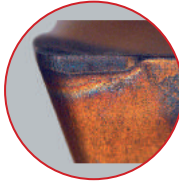

### Plastic Deformation

#### Potential Problem

- Caused by high thermal stress on the cutting edge from excessive feed rate and cutting speed

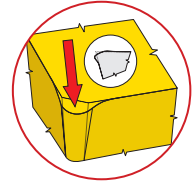

#### Possible Solution

- Use a more wear-resistant grade
- Reduce cutting speed
- Reduce feed rate
- Use coolant or increase coolant flow to the cutting edge

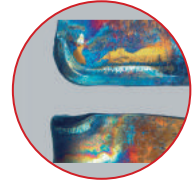

### Cratering

#### Potential Problem

- Appears when the geometry is too neutral or material is too hard for the substrate

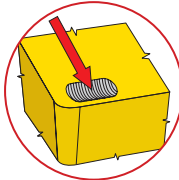

#### Possible Solution

- Use a more wear-resistant grade
- Reduce cutting speed or feed
- Use coolant or increase coolant flow to the cutting edge

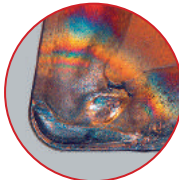

### Chipping of Cutting Edge (Out of Cut)

#### Potential Problem

- Caused by poor chip control
- Can damage the portion of the cutting edge that might not be engaged in the cut

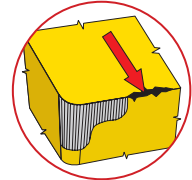

#### Possible Solution

- Change feed rate to gain chip control
- Select a tool with a different approach angle
- Use an insert with a different geometry
- Use a tougher grade of carbide

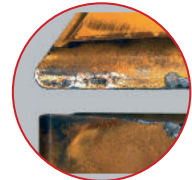

### Notch Wear

#### Potential Problem

- Occurs when cutting edge of insert comes in contact with surface of machined material
- Caused by hardening of surface layer of material and burrs
- Often appears on stainless austenitic steels and other high-temperature alloy steels

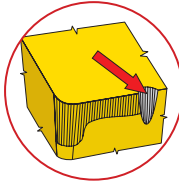

#### Possible Solution

- Use a more wear-resistant grade (Al<sub>2</sub>O<sub>3</sub>)
- Select a tool with a smaller approach angle
- Vary the radial depth of cut
- Use coolant or increase coolant flow to the cutting edge

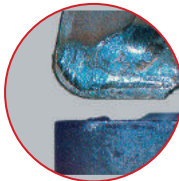

### Insert Fracture

#### Potential Problem

- Caused by workpiece material, grade, condition, the rigidity of the machine-tool workpiece, extent of wear, and cutting conditions

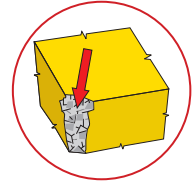

#### Possible Solution

- Use a tougher grade of carbide
- Reduce the feed and depth of cut
- Use an insert with a stronger chip breaker
- Use an insert with a bigger corner radius

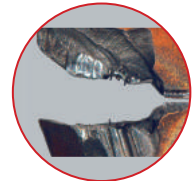





# Guaranteed Test / Demo Application Form

Distributor PO # \_\_\_\_\_

The following must be filled out completely before your test will be considered

**IMPORTANT:** For processing, send Purchase Order to your Allied Field Sales Engineer (FSE). Please clearly mark the paperwork as "Test Order."

## Distributor Information

Company Name: \_\_\_\_\_  
 Contact: \_\_\_\_\_  
 Account Number: \_\_\_\_\_  
 Phone: \_\_\_\_\_  
 Email: \_\_\_\_\_

## End User Information

Company Name: \_\_\_\_\_  
 Contact: \_\_\_\_\_  
 Industry: \_\_\_\_\_  
 Phone: \_\_\_\_\_  
 Email: \_\_\_\_\_

**Current Process** List all tooling, coatings, substrates, speeds and feeds, tool life, and any problems you are experiencing

\_\_\_\_\_

\_\_\_\_\_

**Test Objective** List what would make this a successful test (i.e. penetration rate, finish, tool life, hole size, etc.)

\_\_\_\_\_

\_\_\_\_\_

## Application Information

Hole Diameter: _____ in/mm	Tolerance: _____	Material: _____ (4150 / A36 / Cast Iron / etc.)
Preexisting Diameter: _____ in/mm	Depth of Cut: _____ in/mm	Hardness: _____ (BHN / Rc)
Required Finish: _____ RMS	State: _____	(Casting / Hot rolled / Forging)

## Machine Information

Machine Type: _____ (Lathe / Screw machine / Machine center / etc.)	Builder: _____ (Haas, Mori Seiki, etc.)	Model #: _____
Shank Required: _____ (CAT50 / Morse taper, etc.)	Power: _____ HP/KW	Thrust: _____ lbs/N
Rigidity: _____ <input type="checkbox"/> Excellent <input type="checkbox"/> Good <input type="checkbox"/> Poor	Orientation: _____ <input type="checkbox"/> Vertical <input type="checkbox"/> Horizontal	Tool Rotating: _____ <input type="checkbox"/> Yes <input type="checkbox"/> No

## Coolant Information

Coolant Delivery: _____ (Through tool / Flood)	Coolant Pressure: _____ PSI / bar
Coolant Type: _____ (Air mist, oil, synthetic, water soluble, etc.)	Coolant Volume: _____ GPM / LPM

## Requested Tooling

QTY	Item Number

QTY	Item Number



**Allied Machine & Engineering**  
 120 Deeds Drive  
 Dover, OH 44622

Telephone: (330) 343-4283  
 Toll Free USA & Canada: (800) 321-5537  
 Fax: (330) 602-3400  
 Email: info@alliedmachine.com

## Warranty Information



Allied Machine & Engineering ("Allied Machine") warrants to original equipment manufacturers, distributors, industrial and commercial users of its products for one year from the original date of sale that each new product manufactured or supplied by Allied Machine shall be free from defects in material and workmanship.

Allied Machine's sole and exclusive obligation under this warranty is limited to, at its option, without additional charge, replacing or repairing this product or issuing a credit. For this warranty to be applied, the product must be returned freight prepaid to the plant designated by an Allied Machine representative and which, upon inspection, is determined by Allied Machine to be defective in material and workmanship.

Complete information as to operating conditions, machine, setup, and the application of cutting fluid should accompany any product returned for inspection. This warranty shall not apply to any Allied Machine products which have been subjected to misuse, abuse, improper operating conditions, improper machine setup or improper application of cutting fluid or which have been repaired or altered if such repair or alteration, in the judgement of Allied Machine, would adversely affect the performance of the product.

THIS WARRANTY IS IN LIEU OF ALL OTHER WARRANTIES, EXPRESS OR IMPLIED, INCLUDING ANY IMPLIED WARRANTY OF MERCHANTABILITY OR FITNESS FOR A PARTICULAR PURPOSE. Allied Machine shall have no liability or responsibility for any claim, whether in contract, tort or otherwise, for any loss or damage arising out of, connected with, or resulting from the manufacture, sale, delivery or use of any product sold hereunder, in excess of the cost of replacement or repair as provided herein.

Allied Machine shall not be liable in contract or in tort (including, without limitation, negligence, strict liability or otherwise) for economic losses of any kind or for any special, incidental, indirect, consequential, punitive or exemplary damages arising in any way out of the performance of, or failure to perform this agreement.

ALL PRICES, DELIVERIES, DESIGNS, AND MATERIALS ARE SUBJECT TO CHANGE WITHOUT NOTICE.



Allied Machine & Engineering  
is registered to  
ISO 9001:2015 by DQS



Wohlhaupter GmbH  
is registered to  
ISO 9001:2015 by QA TECHNICH

## United States

### Allied Machine & Engineering

120 Deeds Drive  
Dover OH 44622  
United States

**Phone:**  
+1.330.343.4283

**Fax:**  
+1.330.602.3400

**Toll Free USA and Canada:**  
800.321.5537

**Toll Free USA and Canada:**  
800.223.5140

### Allied Machine & Engineering

485 W Third Street  
Dover OH 44622  
United States

**Phone:**  
+1.330.343.4283

**Fax:**  
+1.330.364.7666  
(Engineering Dept.)

**Toll Free USA and Canada:**  
800.321.5537

## Europe

### Allied Machine & Engineering Co. (Europe) Ltd.

93 Vantage Point  
Pensnett Estate  
Kingswinford  
West Midlands  
DY6 7FR England

**Phone:**  
+44 (0) 1384.400900

### Wohlhaupter GmbH

Maybachstrasse 4  
Postfach 1264  
72636 Frickenhausen  
Germany

**Phone:**  
+49 (0) 7022.408.0

**Fax:**  
+49 (0) 7022.408.212

## Asia

### Wohlhaupter India Pvt. Ltd.

B-23, 3rd Floor  
B Block Community Centre  
Janakpuri, New Delhi - 110058  
India

**Phone:**  
+91 (0) 11.41827044

Your local Allied Machine representative:

[www.alliedmachine.com](http://www.alliedmachine.com)

Allied Machine & Engineering is registered to **ISO 9001:2015** by DQS  
Wohlhaupter GmbH is registered to **ISO 9001:2015** by QTA TECHNIC

